

CLEANFIX KIT FOR CLAAS TRACTORS

OPERATING INSTRUCTIONS

Type: A42 / A64
Engine Rating: 920/930/940/950/960/960
Emission Stage: V
Serial Number: A4200050 – A4209999
A6400050 – A6409999

Cleanfix Kit Number: 217662 Cleanfix-Kit_Claas_Axion_900

Valid only for vehicles with compressed air system



<https://cleanfix.org/instructions-claas>

EN: Scan QR-Code to get instructions in other languages.
DE: QR-Code scannen um Anleitung in weiteren Sprachen zu erhalten.
FR: Scanner le code QR pour obtenir des instructions dans d'autres langues.
IT: Scansione QR-Code per ottenere istruzioni in altre lingue.
ES: Escanea el Código QR para obtener instrucciones en otros idiomas.
PT: Digitalize o Código QR para obter instruções noutras línguas.
TR: Diğer dillerdeki talimatlar için QR kodunu tarayın.



Contents

1	General information	4
1.1	Legal notice	4
1.1.1	Copyright.....	4
1.1.2	Manufacturer and service address.....	4
1.2	Introduction	5
1.2.1	Target group of these operating instructions.....	5
1.2.2	Liability and damages.....	5
1.2.3	Validity	5
1.2.4	Product identification	6
1.2.5	Typographical conventions	7
1.2.6	Safety information in the text	8
1.3	Product description.....	9
1.3.1	Pneumatic fan components	9
1.3.2	Cleanfix® electrical components	9
2	Safety	10
2.1	Intended use.....	10
2.2	Other regulations.....	10
2.3	Safety information	11
3	Required tools.....	14
4	Removing the manufacturer's components.....	15
5	Installing the Cleanfix® fan components	16
5.1	Preparing the original fan shroud.....	16
5.2	Adapting the intake tube for the air filter	18
5.3	Mounting the Cleanfix® flange.....	22
5.3.1	Checking the flange axial and radial circular runout.....	23
5.4	Mounting the Cleanfix® reversible fan	24
5.4.1	Checking the smooth movement of the Cleanfix® reversible fan	27

6	Installing the Cleanfix® electrical components	29
6.1	Cleanfix® valve unit / for vehicles with a compressed air system	30
6.1.1	Mounting the Cleanfix® valve	31
6.1.2	Installing the overflow valve.....	33
6.1.3	Connecting the pressure hose to the overflow valve and the Cleanfix® valve	36
6.1.4	Running the pressure hose of the Cleanfix® reversible fan to the Cleanfix® valve	38
6.1.5	Mounting the push button and cabling to the valve	41
6.1.6	Connecting the Cleanfix® valve and switch to the vehicle's power supply	47
6.1.7	Mounting the Cleanfix speed sensor.....	52
6.1.8	Preparing the frame.....	53
6.1.9	Attaching the speed sensor	55
6.1.10	Adapting the cable/hose feedthrough	56
6.1.11	Running the speed sensor cables	58
7	Operation.....	64
7.1	Initial start-up.....	64
7.2	Cleanfix® valve / for vehicles with a compressed air system	64
8	Maintenance	65
8.1	Servicing the Cleanfix® reversible fan	65
8.2	Servicing the Cleanfix® electrical components	65
9	Troubleshooting.....	66
9.1	Troubleshooting Cleanfix® reversible fans	66

1 General information

1.1 Legal notice

TRANSLATED OPERATING INSTRUCTIONS

READ CAREFULLY BEFORE USE.

KEEP THE OPERATING INSTRUCTIONS FOR FUTURE REFERENCE.

1.1.1 Copyright

The copyright is owned by Hägele GmbH, Germany. Copies, incorporation in other media, translations, or the use of excerpt or parts is not permitted without the explicit consent of Hägele GmbH. All rights reserved. The contents of these operating instructions may be changed without notice. Technical data subject to change.

1.1.2 Manufacturer and service address



Hägele GmbH

Am Niederfeld 13

73614 Schorndorf

Germany

Tel.: +49 7181 96988-0

Fax: +49 7181 96988-80

E-mail: info@cleanfix.org

Website: <http://www.cleanfix.org>

Service:

Tel.: +49 7181 96988-36

E-mail: service@cleanfix.org

Our customer service department or one of our representatives around the world is available at any time to answer further questions.

1.2 Introduction

Before installing or starting up the Cleanfix® reversible fan, familiarize yourself with the contents of these operating instructions. This facilitates safe and efficient handling of the product.

The operating instructions are a component of the product and must always be close at hand. This ensures the following:

- accidents are prevented.
- warranty terms are complied with.

1.2.1 Target group of these operating instructions

These operating instructions are intended exclusively for mechanics trained on agricultural machinery.

The product may be installed and started up only by persons who are familiar with the operating instructions, the product, as well as the national laws and regulations concerning work, safety, and accident prevention.

1.2.2 Liability and damages

Since we are not included in technical service updates from the manufacturer, you may be required to make adjustments when installing this product. Hägele GmbH does not assume responsibility for installation and modification costs.

On account of the information provided in these operating instructions, the manufacturer accepts no liability for direct damages or indirect losses arising from improper operation or maintenance. In the same way, we assume no liability for personal injury or property damage caused by untrained personnel or through failure to comply with regulations concerning work, safety, and accident prevention.

No claims for modification of products that have already been delivered may be made on the basis of the data, illustrations, and descriptions in these operating instructions.

For your safety, use only original spare parts and original accessories.

We assume no liability for the use of other products and any resulting damages.

Observe the following before installation or start-up:

- Inspect delivery for damage in transit and for completeness.
- Immediately document in writing any defects and damages.
- Photograph damaged components.
- Send in a written damage report.

1.2.3 Validity

These operating instructions contain information required to install and start up the product.

In addition to the description of the standard features, the operating instructions contain a number of abstractions and exemplary illustrations of optional features. The product features may therefore partially deviate from the descriptions and depictions.

1.2.4 Product identification

The following information is required for inquiries to the manufacturer:

(1) Fan serial number:

- On the side edge of the front housing

Serial number:

--	--	--	--	--	--

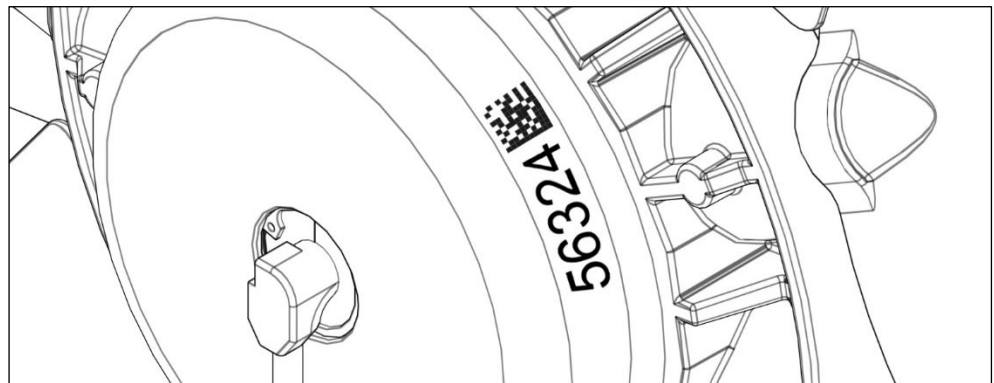

(2) Vehicle:

Manufacturer:

Model:

Operating hours:

(3) Photo of the fan:

1.2.5 Typographical conventions

The following symbols and terms are used in these operating instructions:

- A dot is used for bulleted lists.
- ▶ A triangle is used for actions to be performed.
- An arrowhead is used for measures to avoid risks.
- [+] A plus sign indicates an optional feature that is not included in the standard features.
- (1) A number in parentheses is used for labeling of illustrations.



The “Information” pictograph points out tips and additional information.



The “Additional information” pictograph points out cross-references to information from other documentation.

1.2.6 Safety information in the text

Safe use is possible only if all information necessary for safe operation is observed.

The safety information warns users about risks and informs them how to avoid the risks.

General safety information is provided at the beginning of these operating instructions in chapter 2.

Specific warning information appears before a dangerous step.

Safety and warning information that must be followed is highlighted as follows:

Danger to people

 DANGER!

Warns of an extremely dangerous situation in which failure to observe the hazard warning will result in death or major irreversible injury.

 WARNING!

Warns of a dangerous situation in which failure to observe the hazard warning may result in death or major irreversible injury.

 CAUTION!

Warns of a dangerous situation in which failure to observe the hazard warning may result in minor reversible injury.

Danger to property

NOTE

Warns of situations in which failure to observe the information may result in property damage.

In addition, the information and safety rules provided by the manufacturer in the respective vehicle documentation must be observed.

1.3 Product description

1.3.1 Pneumatic fan components

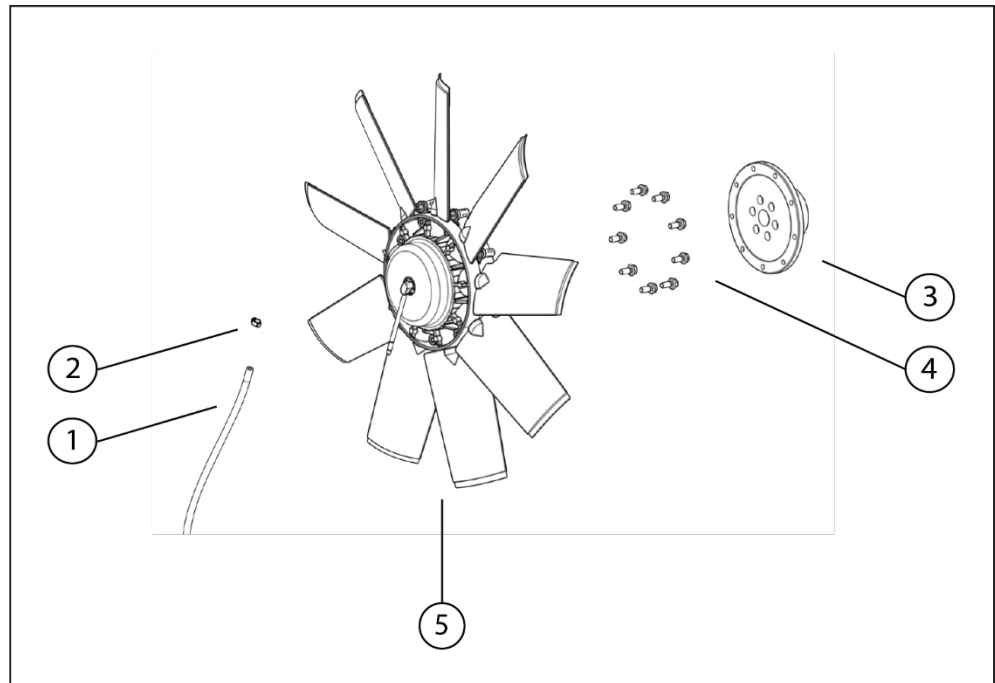

- (1) Pressure hose
- (2) Hose clamp
- (3) Flange
- (4) Flange screws
- (5) Fan

1.3.2 Cleanfix® electrical components

Cleanfix® offers a number of control solutions. The reversing function is activated pneumatically or hydraulically and controlled electronically.

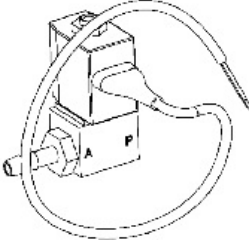
	For vehicles with a compressed air system
Cleanfix® electrical component	Valve 
Reversing function	Switch Press the push button to change from cooling to cleaning. The fan remains in cleaning mode for as long as the switch is pressed.

2 Safety

This chapter provides general safety information.

The individual chapters of the operating instructions also contain specific safety information that is not provided in the "Safety" chapter. Safety information should be observed:

- for your own safety.
- for the safety of others.
- to ensure machine safety.

When commercial vehicles are involved, a number of risks can arise due to improper behavior. For this reason, always work very carefully and not under time pressure.

2.1 Intended use

The product may be used only for the following purposes:

- For cooling commercial vehicles.
- For cleaning the fans of commercial vehicles

Only persons authorized by the manufacturer may make modifications, alterations, and repairs.

The use should be exclusively under normal operating conditions, i.e.:

- Temperature range is between - 30°C to + 35°C.
- Radiator package is cleaned and not clogged
- Radiator grille is cleaned and not clogged.

Under other conditions, the engine power could be partially derated.

In these conditions, during usage, the noise level could be higher compared to the initial system.

As a general principle, unauthorized modifications, alterations, or improper use exempt the manufacturer from liability for resulting damages.

2.2 Other regulations

In addition to these operating instructions, the respective national laws and regulations as amended must be observed (e.g., protective clothing, accident prevention regulations, and occupational health and environmental rules).

2.3 Safety information

WARNING!

Rolling of the vehicle may result in serious injury or death!

An unsecured vehicle can run over or crush bystanders. This can result in serious injury or death.

- Turn off the vehicle.
- Remove the ignition key.
- Secure the vehicle against rolling.

Wearing loose-fitting work clothes may result in serious injury or death!

Loose-fitting clothes can become entangled in rotating parts.

- Wear work and protective clothing stipulated by the employer's liability insurance association.

Working on a machine while it is running may result in serious injury or death!

No work may be performed on the machine while it is running. Objects or persons may be caught, pulled in, or crushed.

- Work only on machines that have been turned off.

Modifications to the fan may result in serious injury or death!

Unauthorized modifications may impair the functioning and/or safety and the service life of the fan. Unauthorized modifications to the fan terminate the manufacturer's warranty and liability. This may result in damage to the machine as well as to serious injury or death.

- Absolutely no modifications may be made to the fan.
-

⚠ CAUTION!**Failure to resolve malfunctions may result in accidents or damage!**

Operation of a defective fan or fan component may lead to accidents or damage.

- Immediately stop the machine.
- Shut down the machine.
- Secure the machine.
- Resolve the fault promptly or engage a vehicle shop.

Activation of the reversing function while persons are standing in front of the vehicle may result in accidents!

The fan generates strong air currents when it is in the cleaning position. Persons standing in front of the vehicle may be struck by flying dirt when the reversing function is activated.

- Nobody may be standing in front of the vehicle when the reversing function is activated.

Activation of the reversing function in closed rooms may result in accidents!

The fan generates strong air currents when it is in the cleaning position. In closed rooms, this may generate dust and result in damage or accidents due to flying parts.

- Use the reversing function only in a safe location and only outside of closed rooms.

Damage caused by lines or tubes that are too loose or are attached to moving parts!

During travel, the installed lines and tubes are subjected to vibrations. As a result, lines or nearby parts may be damaged due to friction.

- All lines and tubes must be securely fastened and must not make contact with moving parts.

NOTE

Property damage may result if the fan is installed directly on the crankshaft or when the fan is driven by a spur gear!

Torsional vibrations from the crankshaft or the spur gear will damage the fan and may cause damage to the vehicle.

- Install Cleanfix[®] vibration dampers between the fan and crankshaft or spur gear.

Reversing the fan while the vehicle is in the red temperature range may result in property damage!

The cooling effect is interrupted when the reversing function is activated. Reversing the fan while the machine is in the red temperature range causes the engine to overheat.

- Do not reverse the fan when the machine is in the red temperature range.
 - Park the vehicle and open the hood so that the vehicle can cool down.
-

3 Required tools

Flange installation

- Magnetic or clamp type dial gauge
- 105 Nm +/-15Nm torque wrench

Fan installation

- 20 Nm torque wrench
- Locking pliers
- Standard tools

Pressure hose installation and connection

- Lubricant
- Pincers
- Standard tools

Electrical component installation and connection

- Standard power and hand tools
- Electric drill
- Stepped cutter or conical drill
- Drill 5 mm
- Drill 6 mm
- M6 tap drill
- Hot-air gun
- Metal hacksaw or angle grinder

4 Removing the manufacturer's components



CAUTION!

Risk of injury due to the hot engine!

A hot engine can burn hands or other body parts

- Turn off the engine.
- Allow the engine to cool down.
- Remove the ignition key.
- Disconnect the battery.

- ▶ Make sure that the engine is turned off.
- ▶ Remove the engine covering at the lower left (1) and right.
- ▶ If necessary, remove the fan guard and safety components to gain access to the manufacturer's installed fan.
- ▶ Remove the drive belt of the original fan at the tensioner.
- ▶ Remove the fan shroud from the radiator.
- ▶ Insert the pre-cut cardboard between the fan shroud and the radiator to protect the radiator.
- ▶ Remove the original fan (2). (left-hand thread)



Read and observe the manufacturer's vehicle manual before removing the manufacturer's fan.

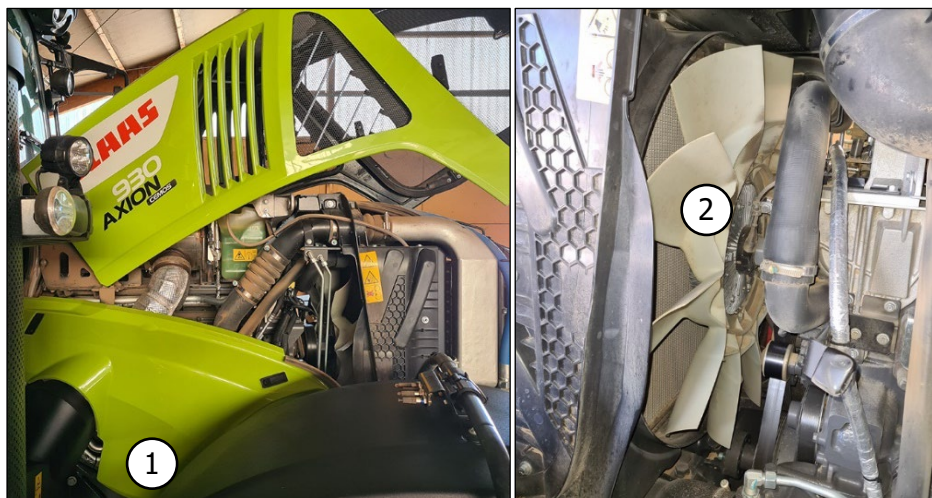

5 Installing the Cleanfix® fan components

5.1 Preparing the original fan shroud

- ▶ Mark the position for the hose feedthrough at the lower left of the fan shroud.
 - Measurement A (left edge of fan shroud) = 50 mm
 - Measurement B (front edge of fan shroud) = 40 mm
- ▶ Drill a 20 mm hole at the mark.

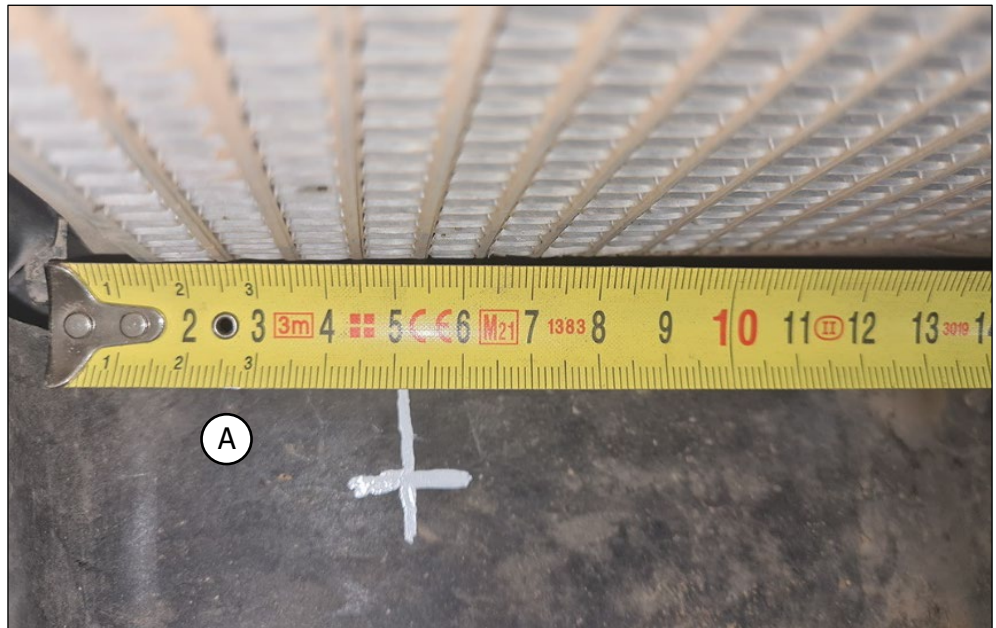

NOTE

Drilling the hose feedthrough hole may cause property damage!

Components lying behind the hose feedthrough may be damaged during drilling.

- Insert the pre-cut cardboard between the fan shroud and the radiator to protect the radiator.
- Cover the bottom of the fan shroud with a metal plate in the drilling area.

- ▶ Insert the hose feedthrough into the radiator cover from the outside and screw on the nut from the inside.
- ▶ Hand-tighten the hose feedthrough.



5.2 Adapting the intake tube for the air filter

- ▶ Remove the intake tube air filter (2), being mindful of the foam material (1) in the process.



- ▶ Mark the intake tube for adaptation.
 - Measurement A (tube opening surface) = 25 mm
 - Measurement B (height of tube on right) = 90 mm
 - Measurement C (height of tube on left) = 100 mm

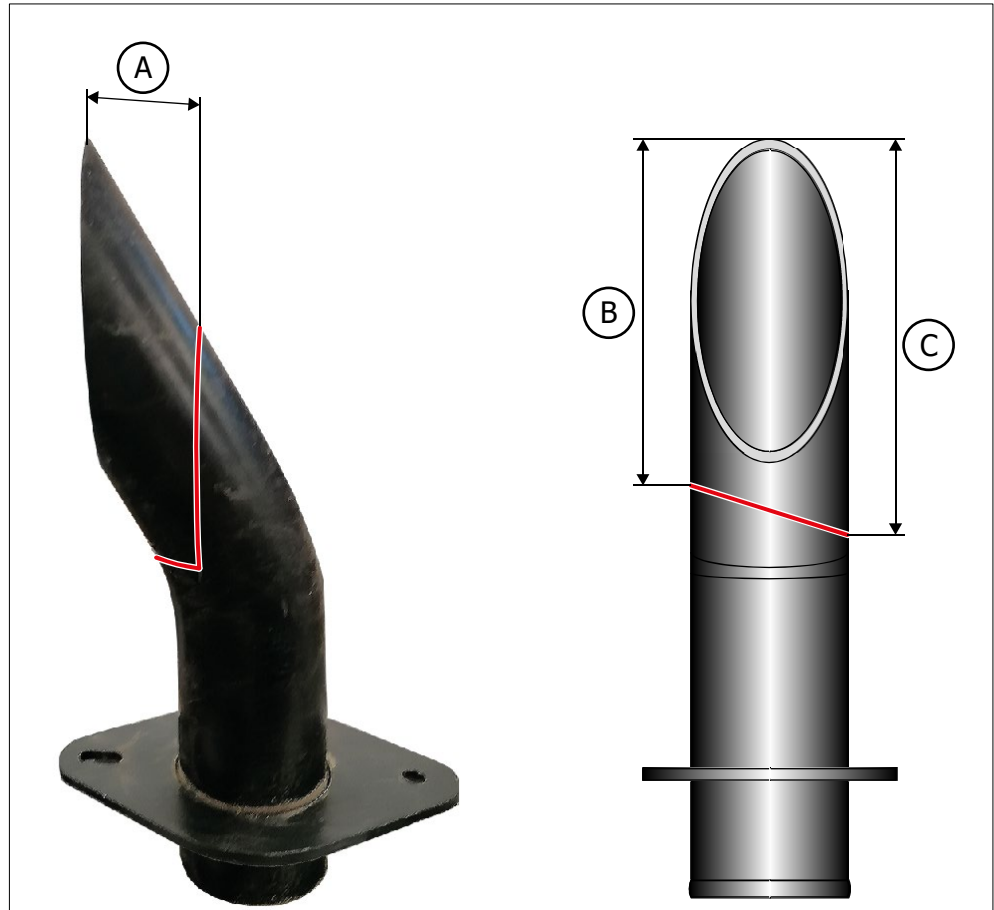

- ▶ Notch the intake tube using the hacksaw.
- ▶ Deburr the intake tube and apply an anti-corrosion coating.

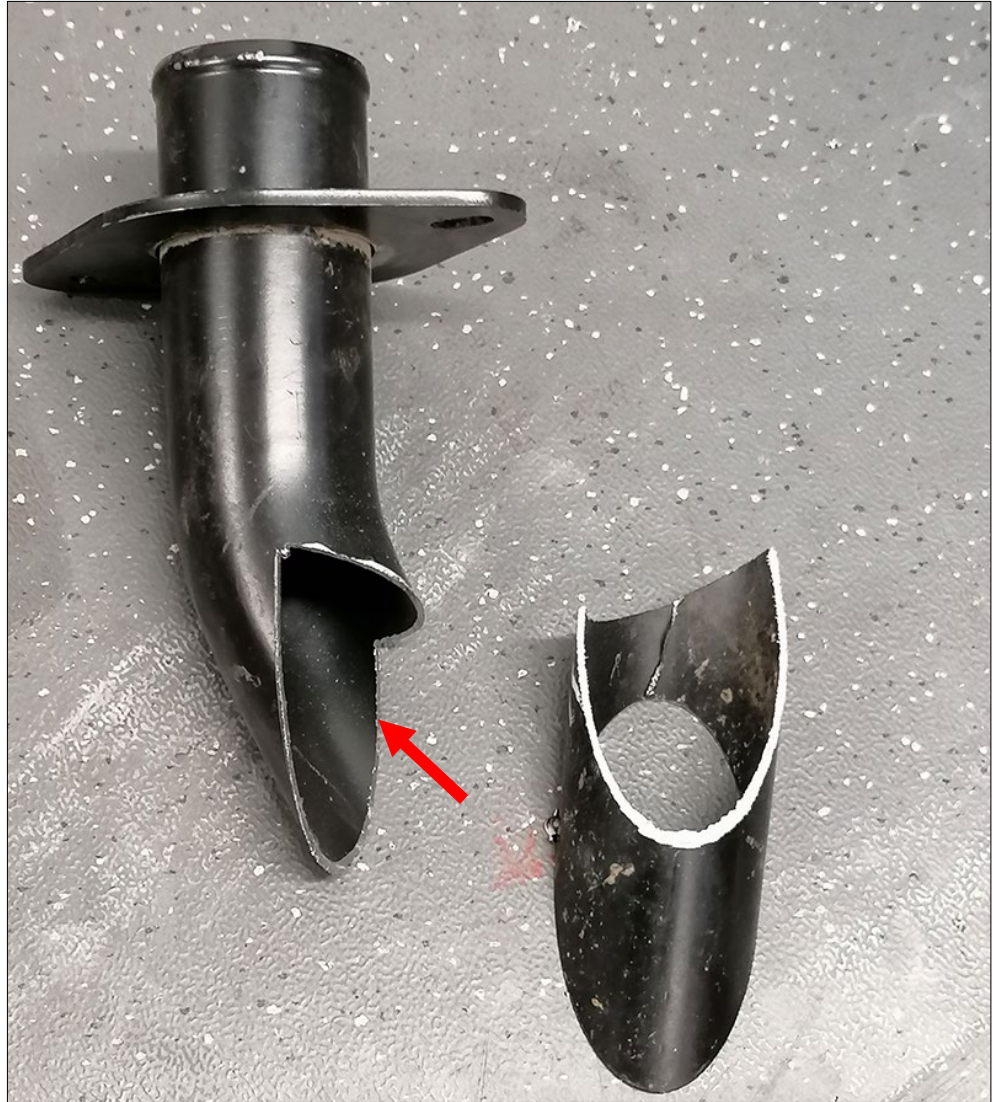

- ▶ Install the intake tube (1), paying attention to the correct seating of the foam material (2).

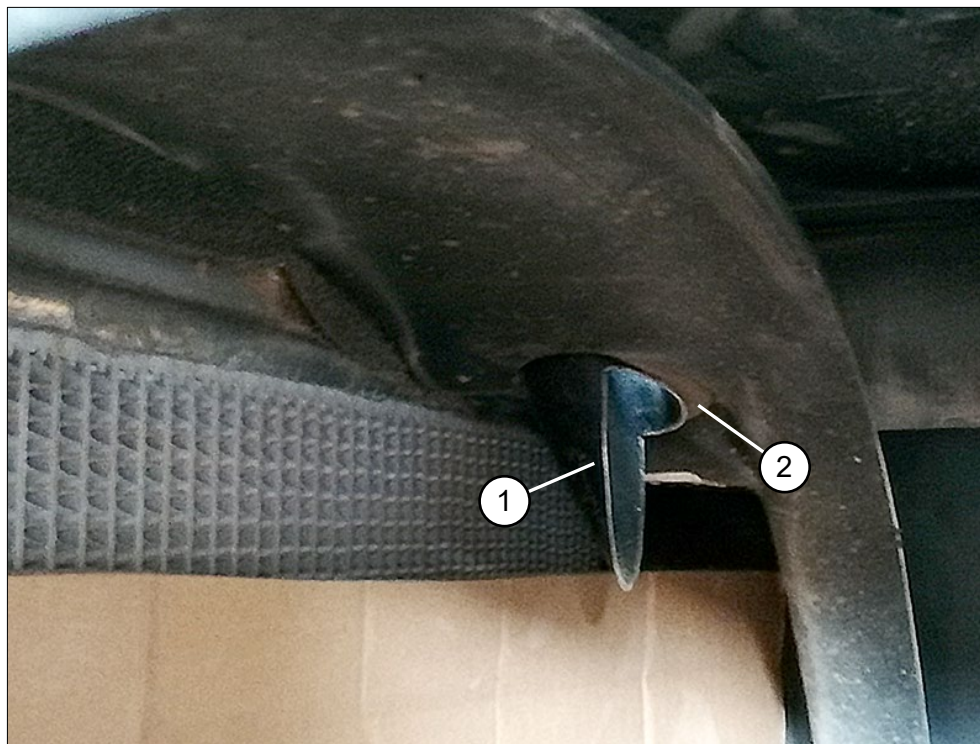

5.3 Mounting the Cleanfix® flange

- ▶ Clean the fan drive mounting surface for the flange to remove all dirt and rust.
- ▶ Set the flange on the drive shaft and apply thread lock adhesive (low/medium strength, e.g., Loctite 243) to the thread.
- ▶ Screw the flange to the drive shaft. (left-hand thread)
- ▶ Tighten the flange to 105 Nm +/-15Nm torque.

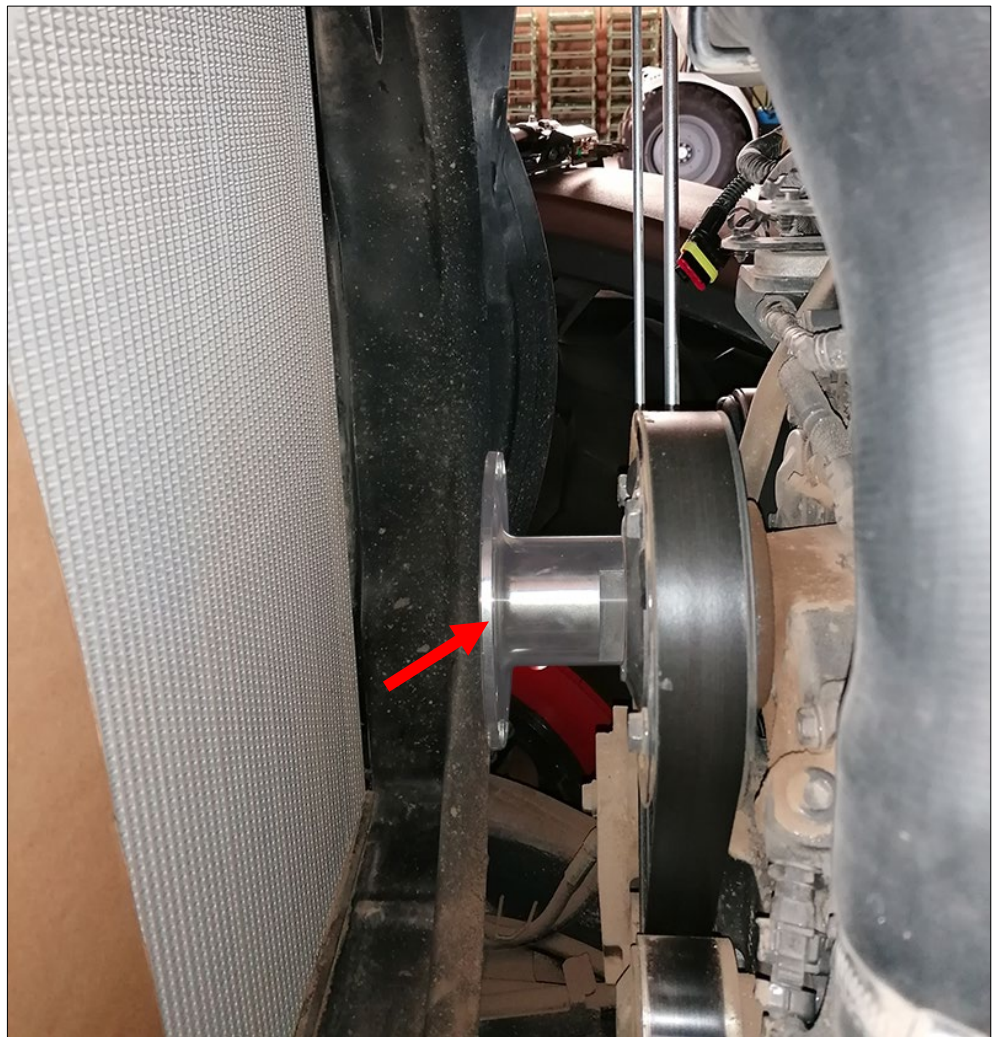

5.3.1 Checking the flange axial and radial circular runout

⚠ WARNING!

Property damage due to axial and radial circular runout!

Imbalances damage the fan and may result in vehicle damage and serious injury.

- The axial and radial circular runout must be checked using a dial gauge and must not exceed 0.1 mm (0.004").
- Check the fan drive mounting surface and the flange for contamination and clean accordingly.
- If necessary, rotate the flange to the next hole and install and measure again.

- ▶ Loosen any belts that drive the fan pulley. This will allow for a more accurate axial and radial circular runout measurement.
- ▶ Check the axial and radial circular runout using a dial gauge. The axial and radial circular runout must not exceed 0.1 mm (0.004").

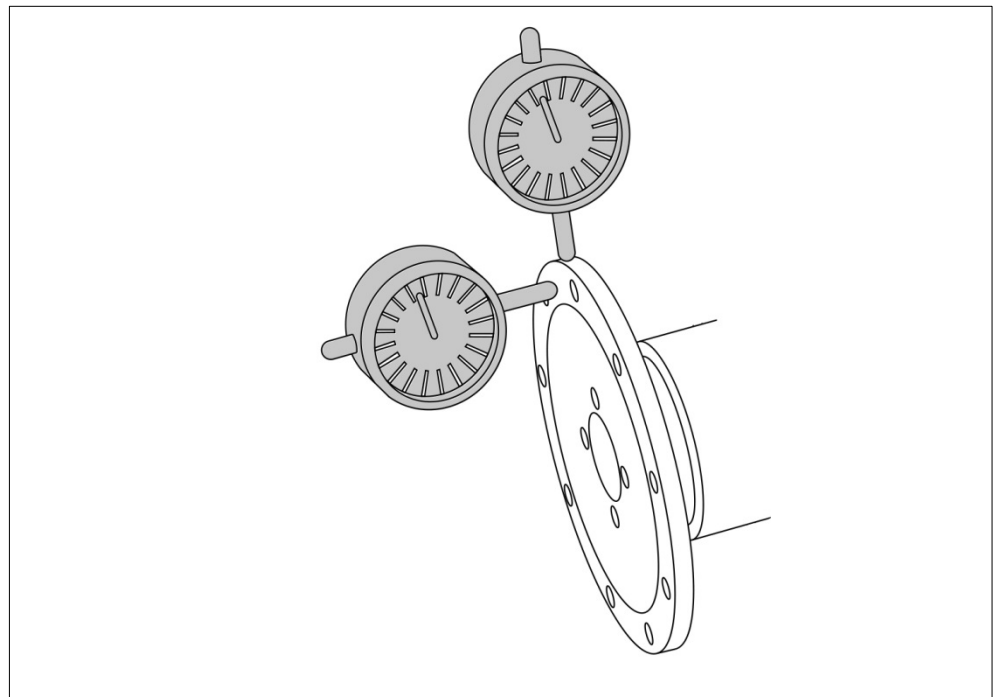

5.4 Mounting the Cleanfix® reversible fan

Optional: Flex-Tips (blade extensions)

To increase the airflow rate, use elastic Flex-Tips to minimise the gap between the blade and the shroud.

Ideal airflow rate is achieved when the gap between the Flex-Tips and the shroud is 1 mm / 0.004". Out-of-roundness of the shroud may cause abrasion of material from the Flex-Tips due to contact with the shroud.

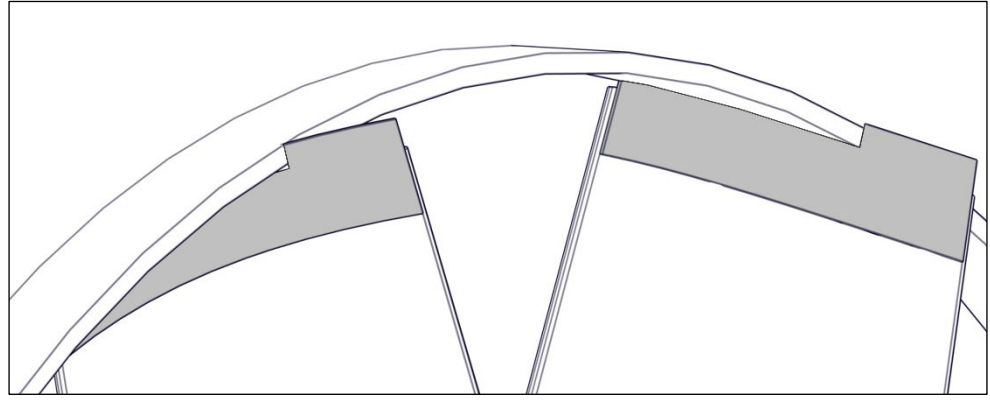

- ▶ Apply a thin layer of lubricant to the end of the air intake tube to make it easier to slide the pressure hose over the air intake tube.
- ▶ Slide the hose clamp over the pressure hose.
- ▶ Slide the pressure hose up to the side marks (25mm; 1") on the air intake tube of the air intake assembly.
- ▶ Make sure that the hose clamp is positioned horizontally.
- ▶ Secure the pressure hose by pinching the ears of the hose clamp with hose clamp pincers.

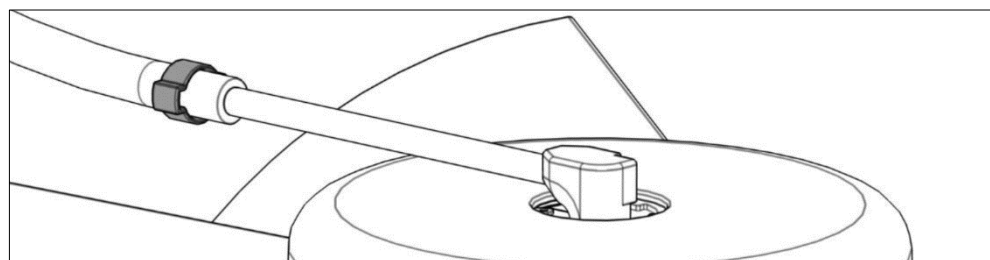

NOTE

An incorrectly mounted hose clamp may cause collision!

The hose clamp must be parallel to the fan as pictured. If the ears of the hose clamp point up and down, the fan blades can hit the hose clamp during operation.

- Rotate the hose clamp using pliers.

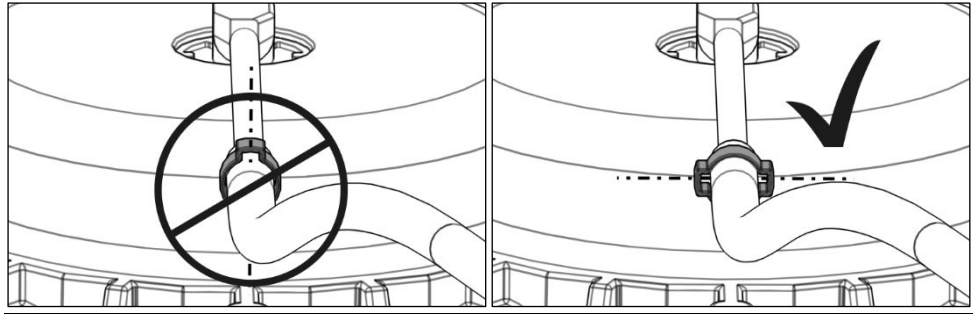

Property damage due to bending of the air intake tube!

If the air intake tube of the air intake assembly is bent down toward the blades during installation, the fan blades will hit the hose during operation.

- Manually bend the air intake tube of the air intake assembly into the original position.

- ▶ Insert the Cleanfix® reversible fan and feed the pressure hose through the hose feedthrough of the fan shroud from the inside to the outside.
- ▶ Attach the Cleanfix® reversible fan to the flange using the supplied locking screws.
- ▶ Tighten the mounting screws (9x) to 25 Nm in a crosswise sequence.

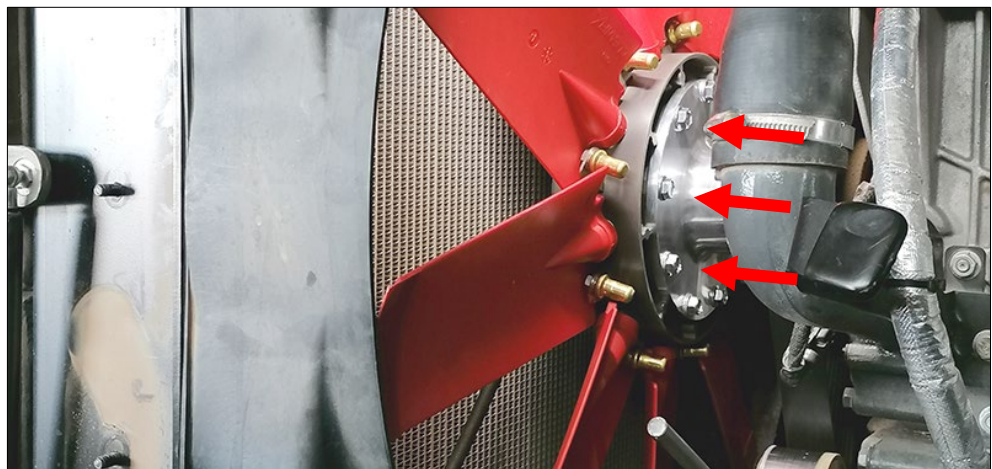

- ▶ Screw the fan shroud to the radiator; be sure to align and center the fan shroud on the Cleanfix® reversible fan.

- ▶ Pull the pressure hose through until it no longer sags but is not strained and tighten the hose feedthrough.

**NOTE**

If the pressure hose is tensioned too tightly, the seals at the air intake assembly will wear and the fan will leak. For an optimum result, it must be possible to rotate the air intake assembly by maximum 15°.

- Make sure that the pressure hose neither makes contact with the fan during operation nor is tensioned too tightly.

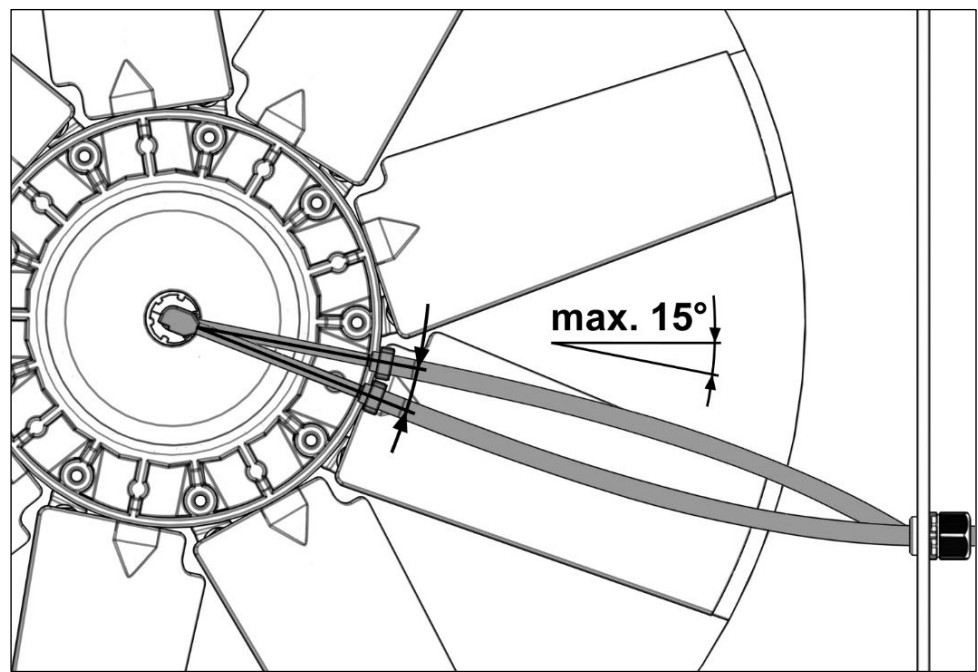

5.4.1 Checking the smooth movement of the Cleanfix® reversible fan

- ▶ Supply compressed air (max. 10 bar or 140 psi) to the fan until the blades turn to their cross position.
- ▶ Use locking pliers to pinch the pressure hose, which will trap the air in the system.
- ▶ Remove the pressure hose from the compressed air supply.

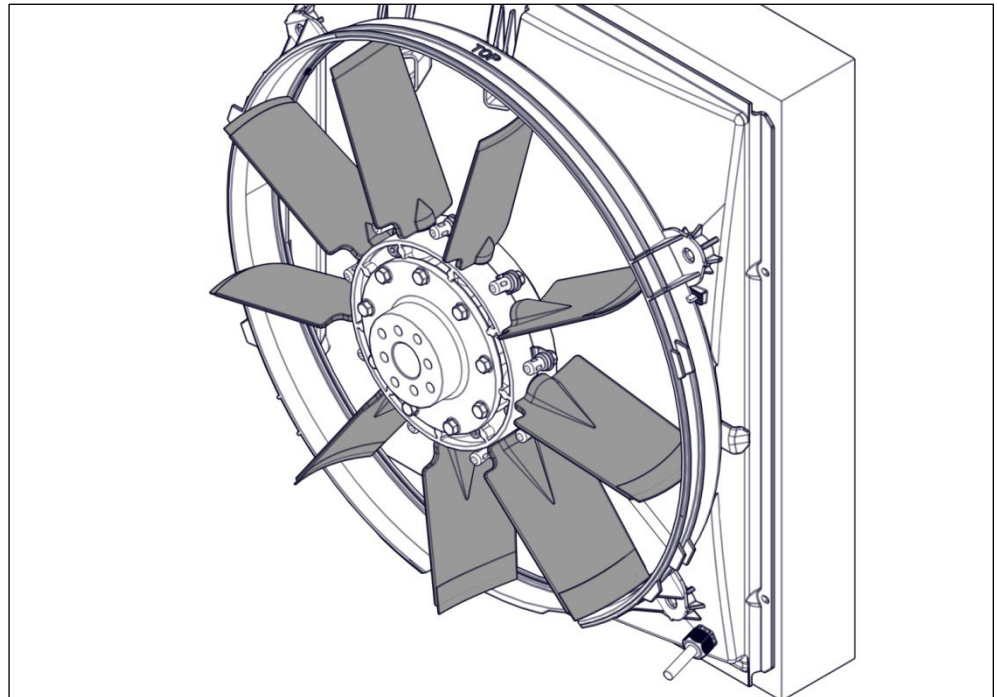

The depicted representation is an example.

NOTE

Property damage due to rotation of the fan with tight drive belts!

Rotation of the fan with tight belts results in excessive force and may result in damage to the fan and drive.

- Loosen the drive belts.

- ▶ Manually rotate the fan.
- ▶ Make sure that the blades do not come into contact with any objects.
- ▶ Make adjustments as needed.

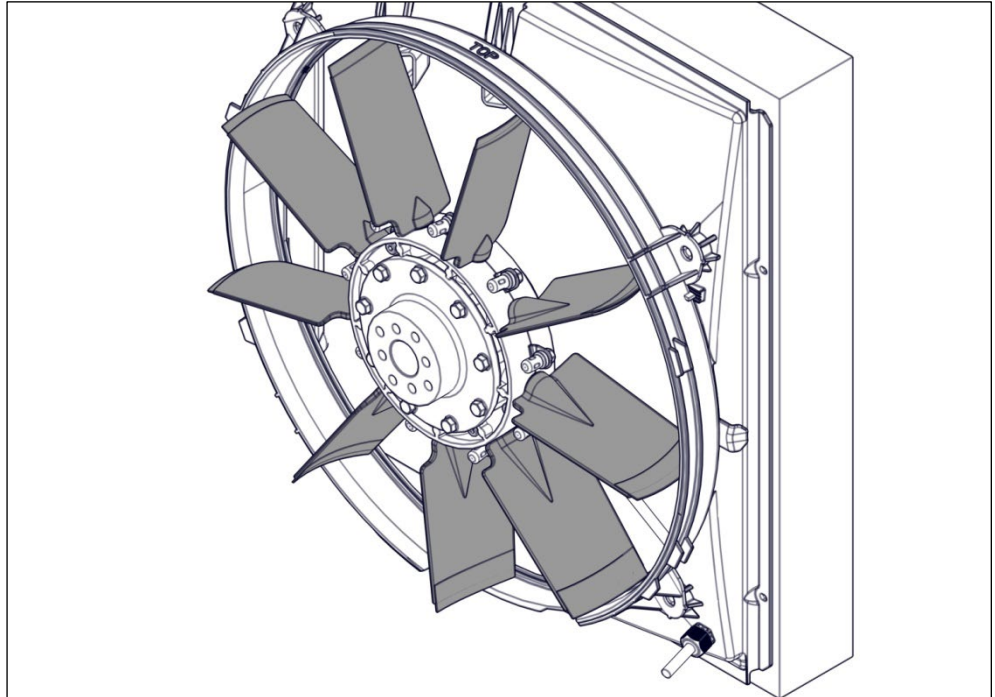

The depicted representation is an example.

- ▶ Remove the locking pliers to vent the fan.

⚠ WARNING!

Pulling in of loose objects!

Loose objects can be pulled into the fan during operation, which may result in damage to the fan and vehicle and cause serious injury!

- Remove loose objects or secure them with plastic ties.

6 Installing the Cleanfix® electrical components

CAUTION!

Damage caused by lines or tubes that are too loose or are attached to moving parts!

During travel, the installed lines and tubes are subjected to vibrations. As a result, lines or nearby parts may be damaged due to friction.

- All lines and tubes must be securely fastened and must not make contact with moving parts.

The Cleanfix® electrical components are installed as described in the following sections. The relevant section must be taken into account depending on the delivered version.

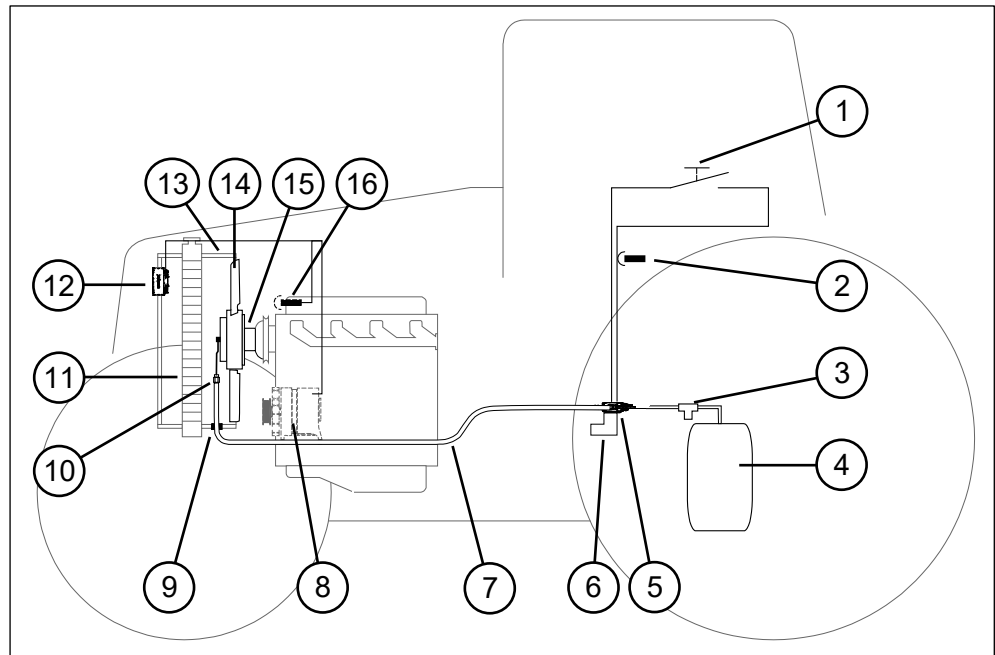
6.1 Cleanfix® valve unit / for vehicles with a compressed air system

- (1) Cleanfix® switch (push button)
- (2) Plug connection in the side console at the lower right
- (3) Overflow valve (min. 6.5 bar or 94 psi, max. 7.0 bar or 102 psi)
- (4) Compressed air reservoir
- (5) Cleanfix® valve
- (6) Valve holder (metal angle)
- (7) Pressure hose
- (8) Generator
- (9) Hose feedthrough
- (10) Hose clamp
- (11) Radiator
- (12) Cleanfix® speed sensor
- (13) Fan shroud
- (14) Cleanfix® reversible fan (pneumatic)
- (15) Flange
- (16) Plug connection of original fan

6.1.1 Mounting the Cleanfix® valve



- (1) Cleanfix® valve
- (2) Connector P (compressed air) of the Cleanfix® valve
- (3) Connector A (fan) of the Cleanfix® valve

- ▶ Remove the left rear wheel to access the vehicle's compressed air supply and the valve installation location.
- ▶ Remove the cover (4).

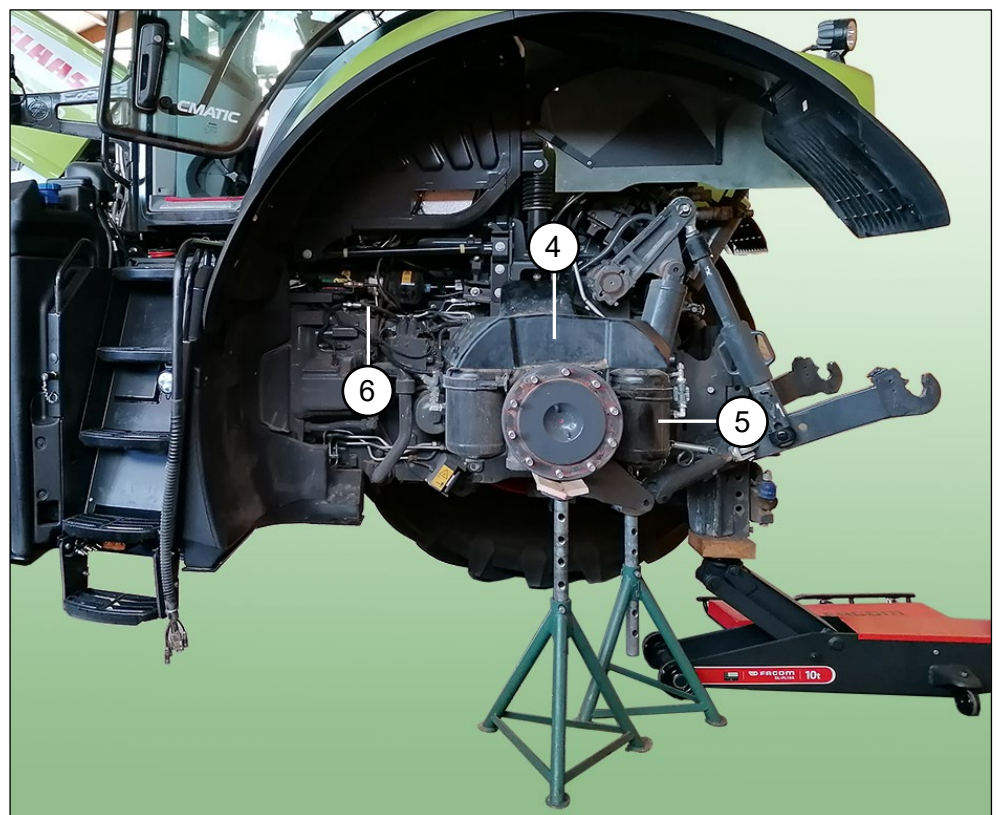

- (4) Cover
- (5) Compressed air reservoir
- (6) Cleanfix® valve installation location

- ▶ Unscrew the screw (7) on the vehicle side.
- ▶ Attach the valve holder (8) to the vehicle using the screw (7).

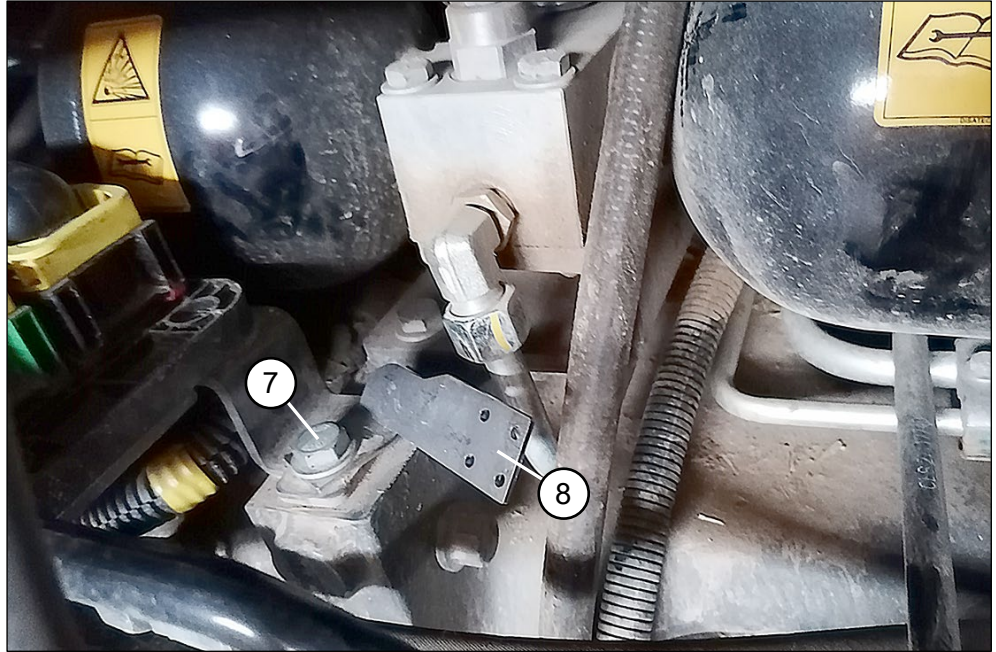

- ▶ Attach the Cleanfix® valve to the valve holder using Phillips screws (M4).



6.1.2 Installing the overflow valve

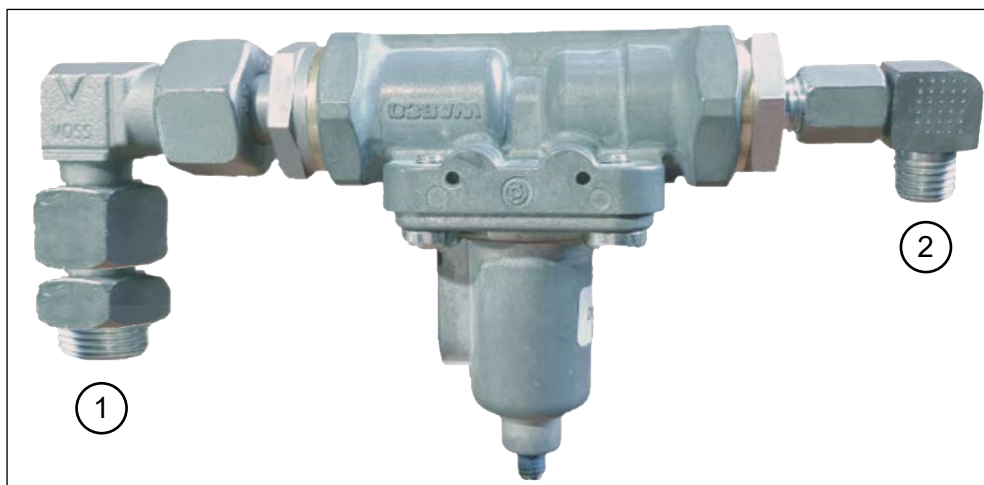

- (1) Connection for compressed air reservoir
- (2) Connection for pressure hose

► Vent the compressed air reservoir at the discharge valve (3).

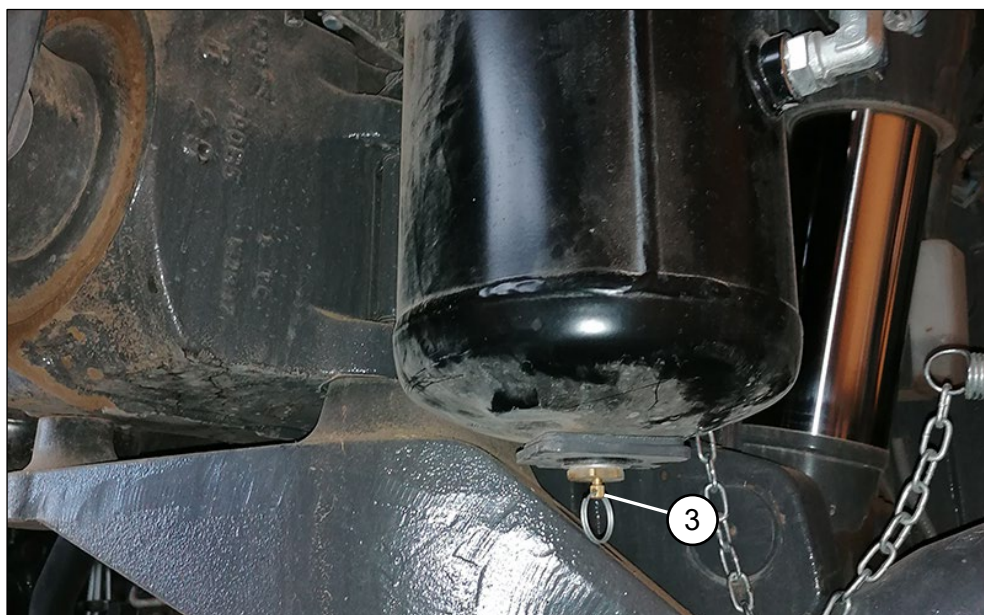

For an overflow valve on the vehicle side

Double check that the overflow valve ensures the pressure limit of 6.5 b or more.

- ▶ Unscrew the compression nut (5) with filler plug (4).

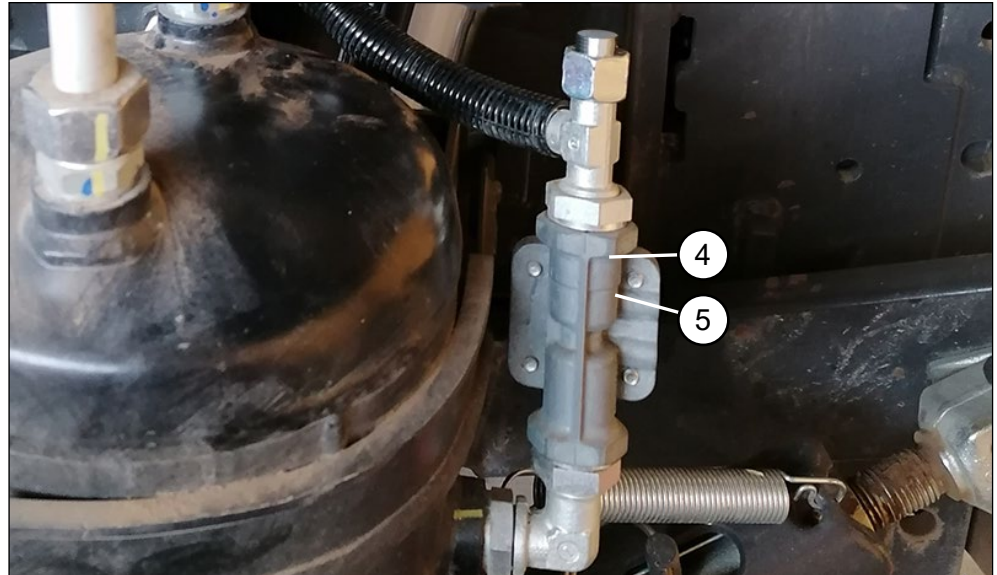

- ▶ Mount the elbow (7) and the connector piece (6) on the overflow valve.

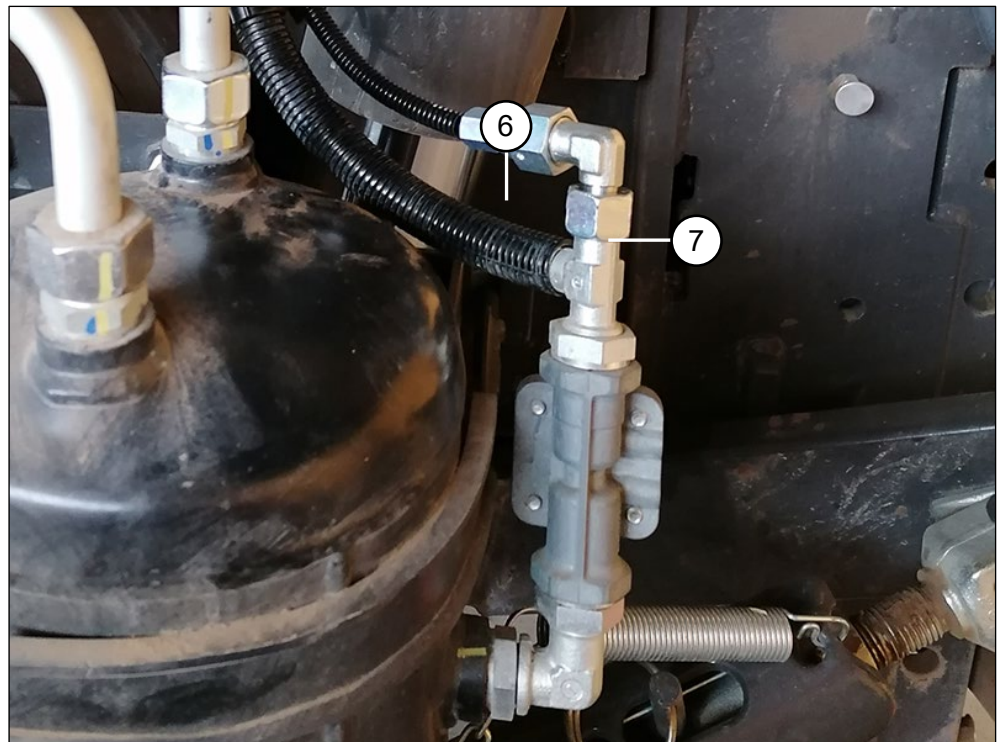

For no overflow valve

- ▶ Remove the filler plug on the pressure reservoir.
- ▶ Mount the straight screwed coupling (9) and overflow valve (10) on the compressed air reservoir with the O-ring and support ring and screw them in tight.

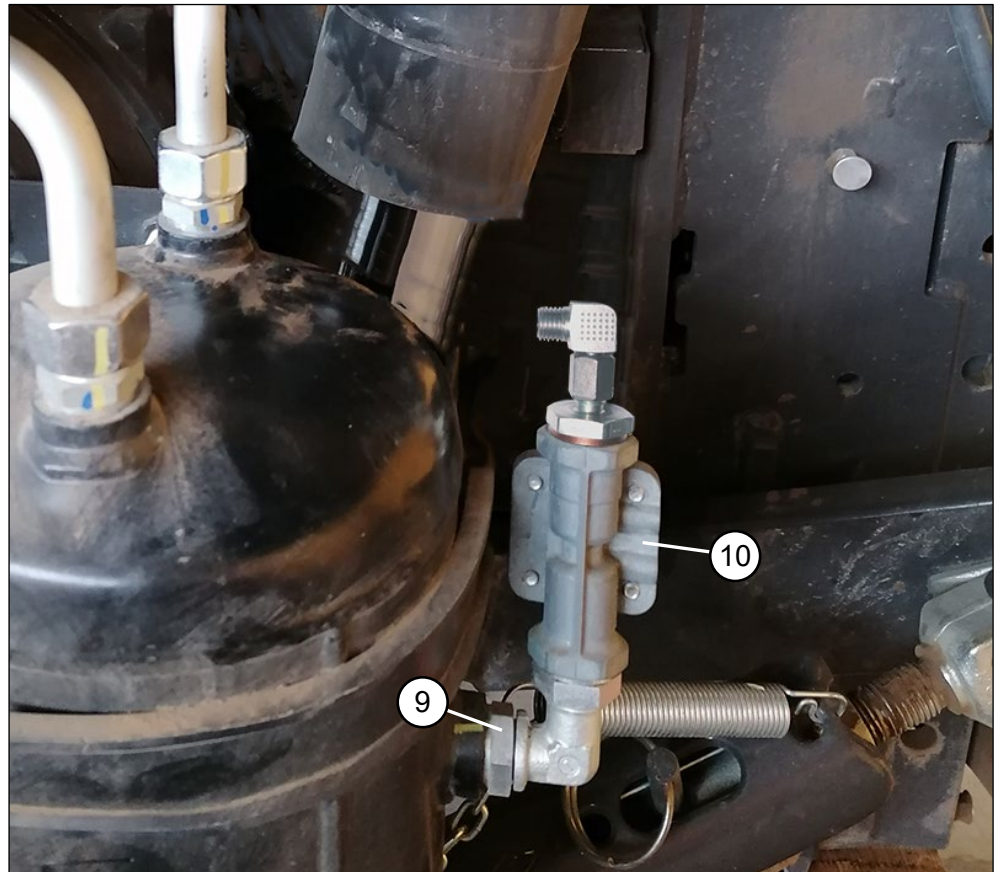
**NOTE**

Contact of the overflow valve with components may cause property damage and leaking!

- After the overflow valve is tightened, it must not touch any objects.

6.1.3 Connecting the pressure hose to the overflow valve and the Cleanfix® valve

- ▶ Connect the pressure hose with the tubular stiffener and cutting ring to the overflow valve.

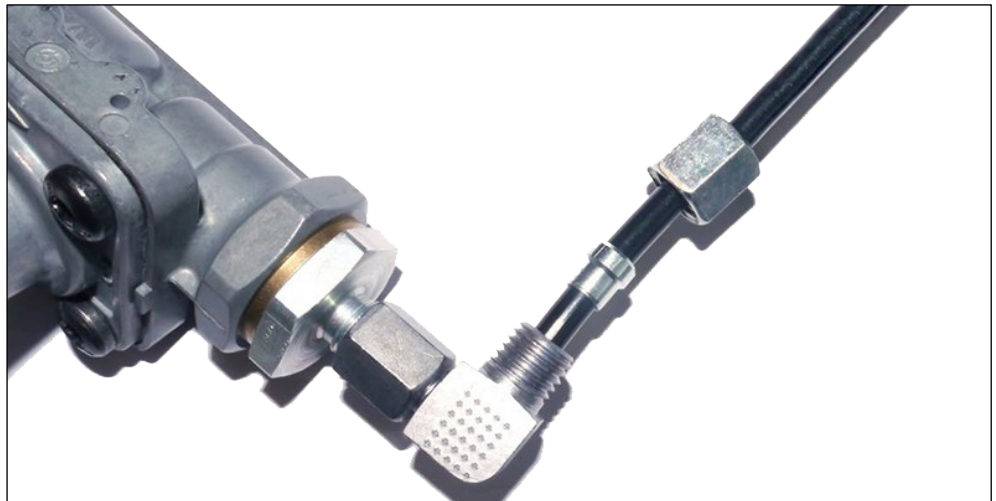

- ▶ Slide the corrugated tube over the pressure hose.
- ▶ Run the pressure hose to the Cleanfix® valve along the existing pressure line (see image).
- ▶ Connect the pressure hose to connector P of the Cleanfix® valve.

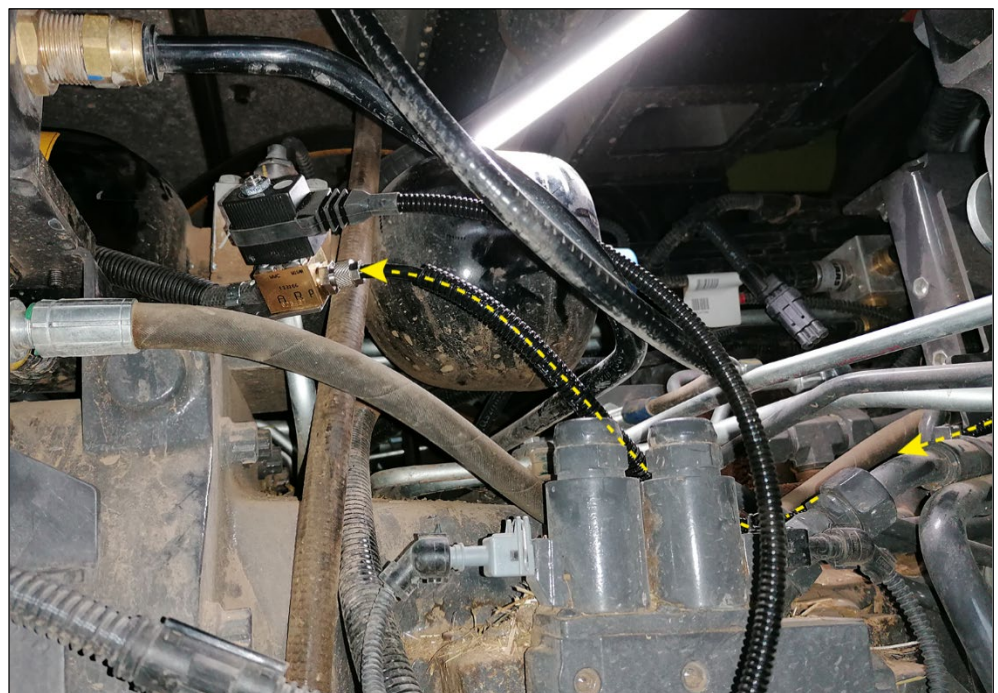
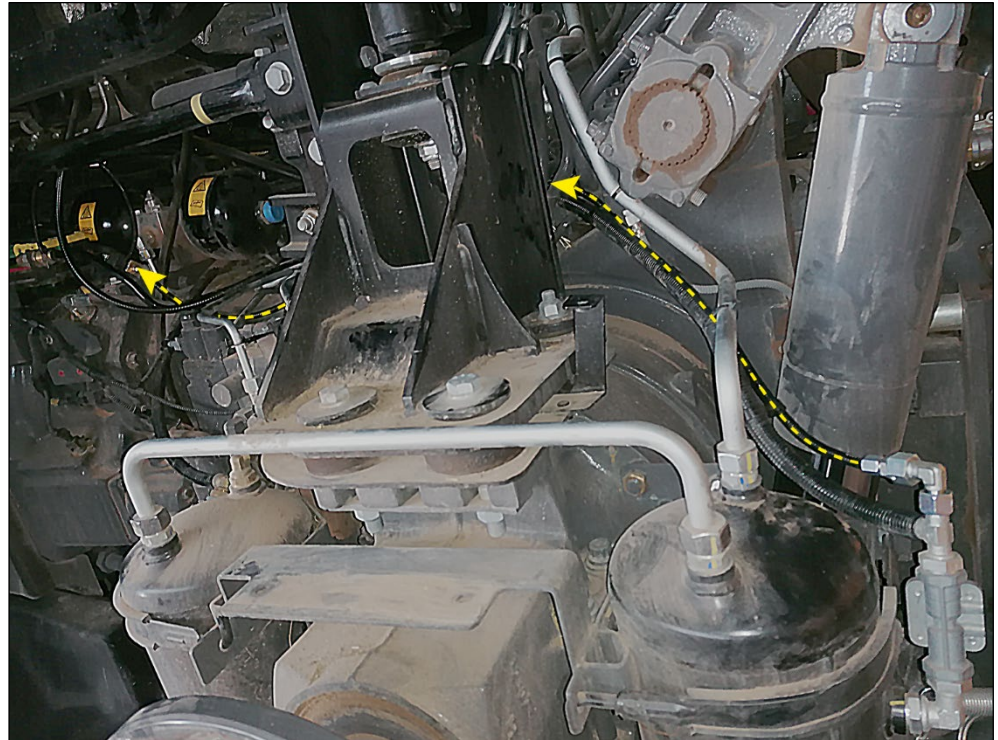

6.1.4 Running the pressure hose of the Cleanfix® reversible fan to the Cleanfix® valve

- ▶ Slide the corrugated tube over the pressure hose.
- ▶ Run the pressure hose with corrugated tube as pictured.

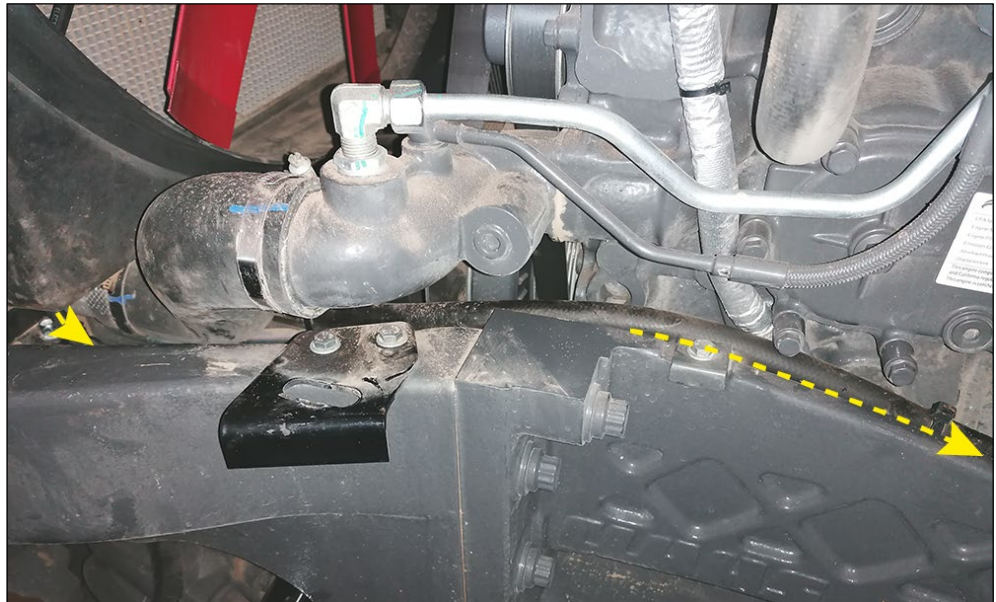

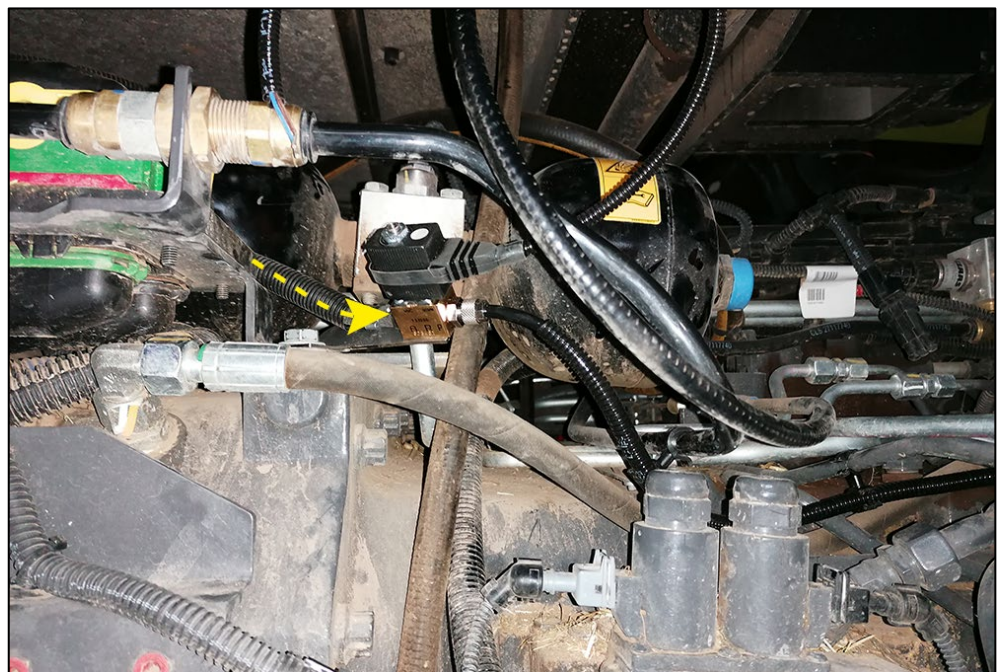
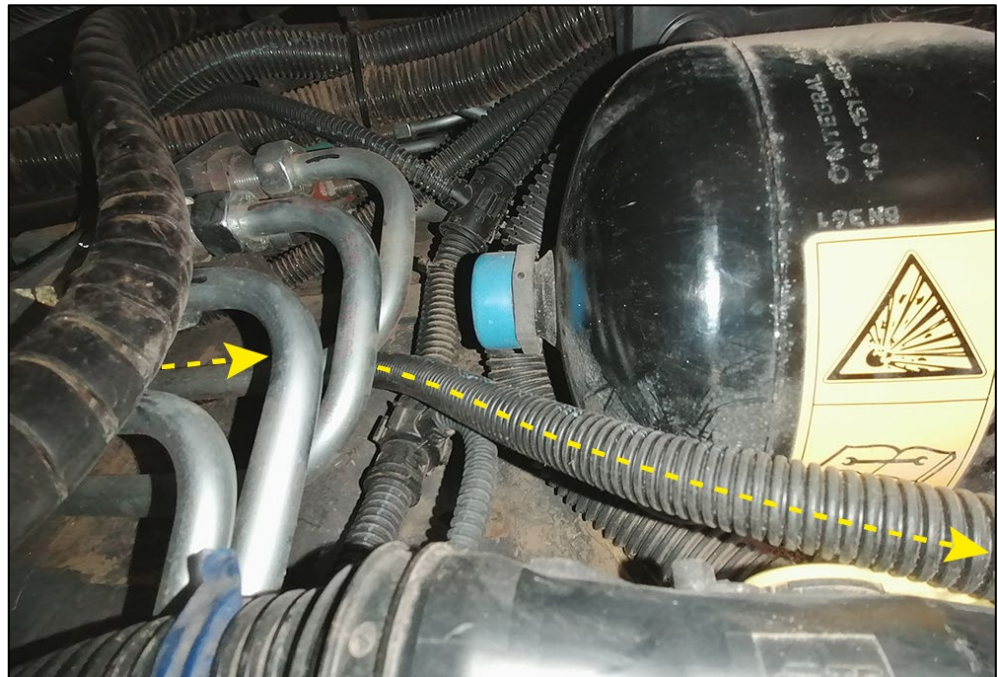
**NOTE**

Property damage due to contact of the corrugated tube with hot pipes!

- The minimum clearance of 10 mm (0.4") to other cables and tubes must be observed.

- ▶ Use the supplied rotatable corrugated tube holders to attach the corrugated tube to adjacent cables or tubes.

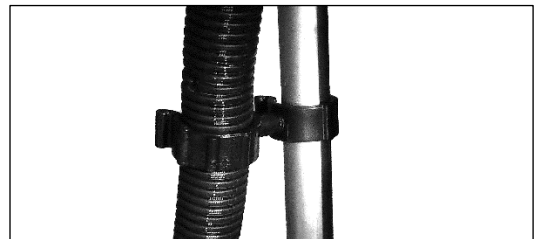
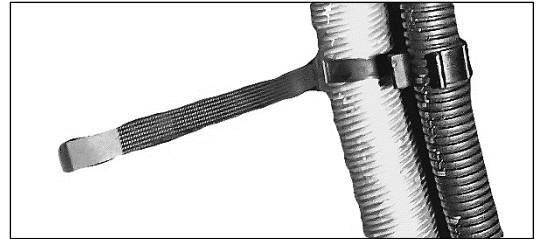

- ▶ Slide the hose clamp over the pressure hose with corrugated tube.
- ▶ Connect the pressure hose with corrugated tube to connector A of the Cleanfix® valve.
- ▶ Secure the pressure hose using the supplied hose clamp.

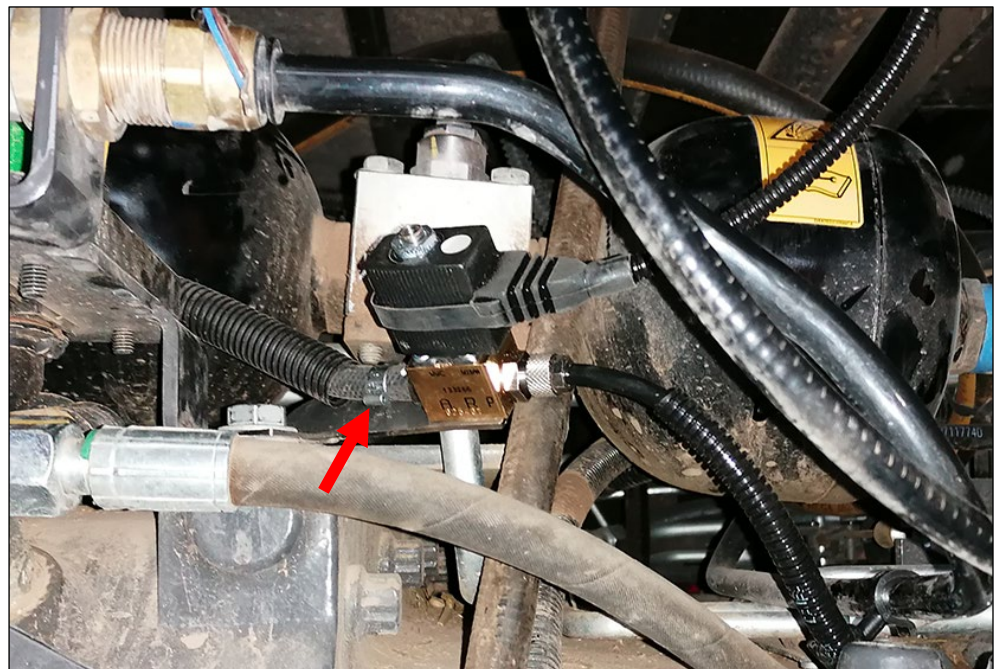

6.1.5 Mounting the push button and cabling to the valve

Installation location: side console

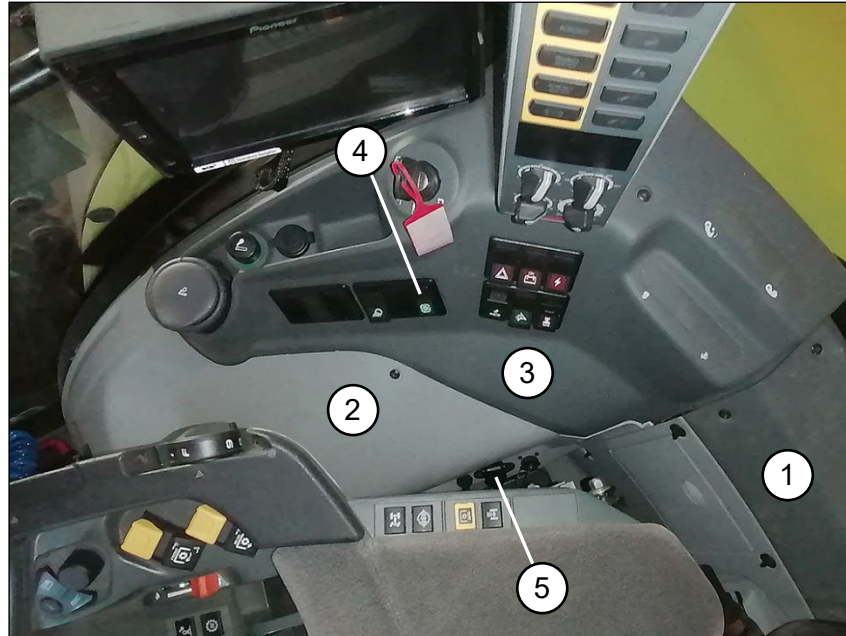

- (1) Rear covers
- (2) Side cover on right
- (3) Console cover
- (4) Cleanfix® push button installation location
- (5) 3-pole outlet for the power supply

- ▶ Remove the rear covers according to the instructions in the vehicle manual.
- ▶ Remove the side cover on the right.
- ▶ Carefully remove the mounting frame with switches and covers from the console cover.



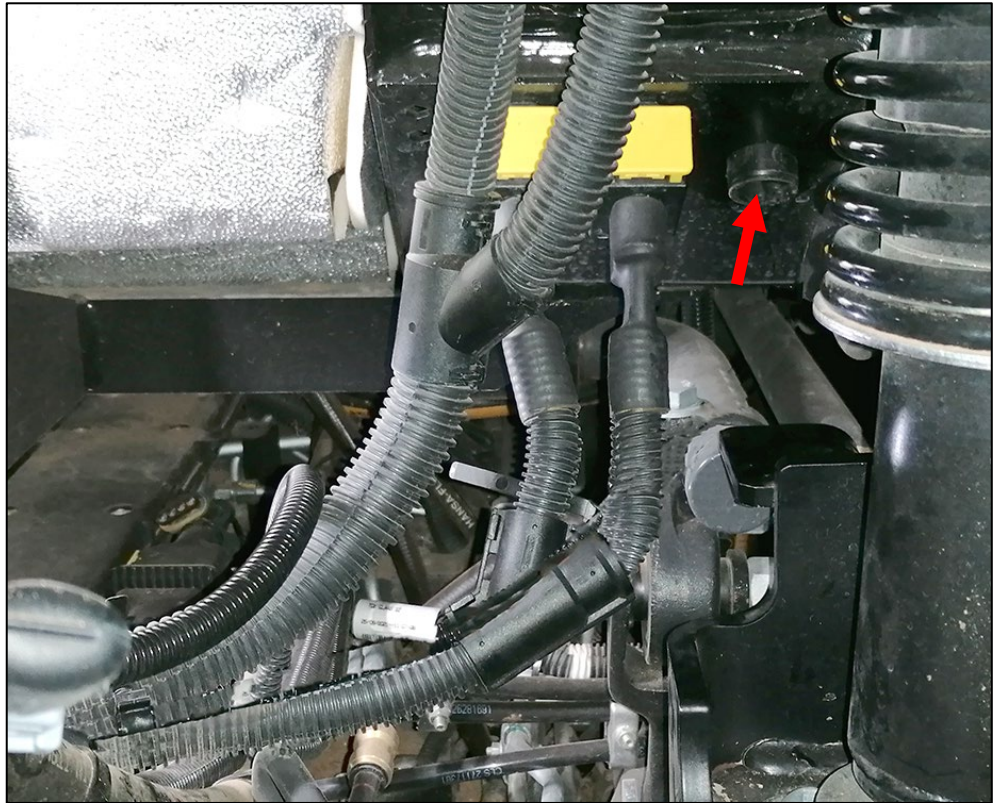

Plug for the cable gland: view from outside the cab in the back at the right

- ▶ Remove the plug for the cable gland from the inside.

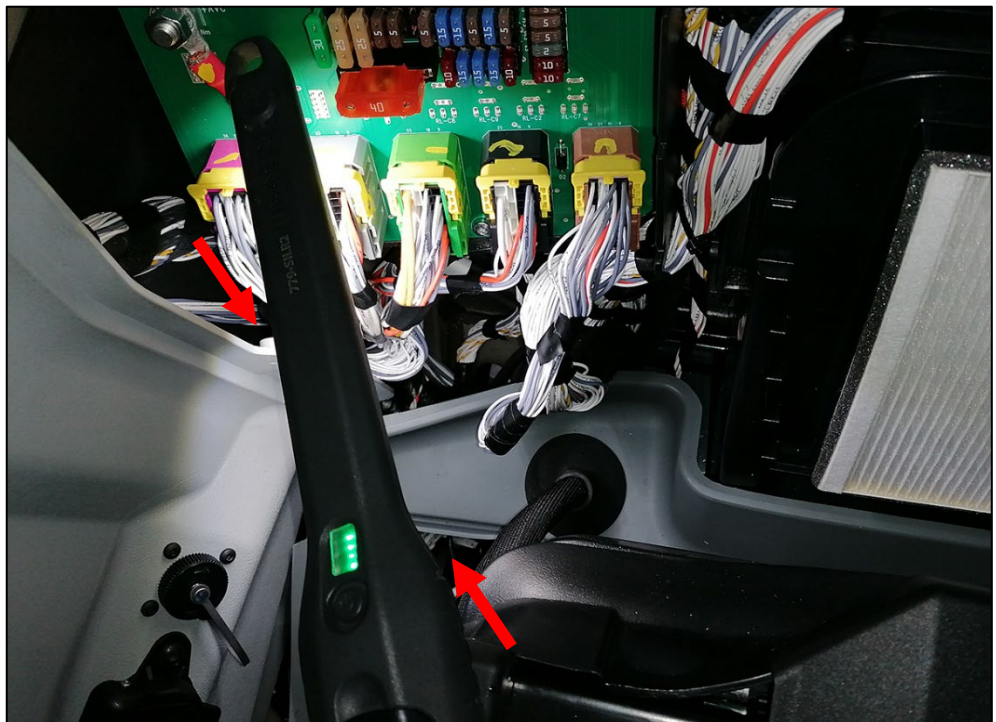

Plug for the cable gland: view from inside the cab in the back at the right

- ▶ Drill a hole in the plug for the cable gland using a 6 mm drill.
- ▶ Guide the cable through the plug as shown.

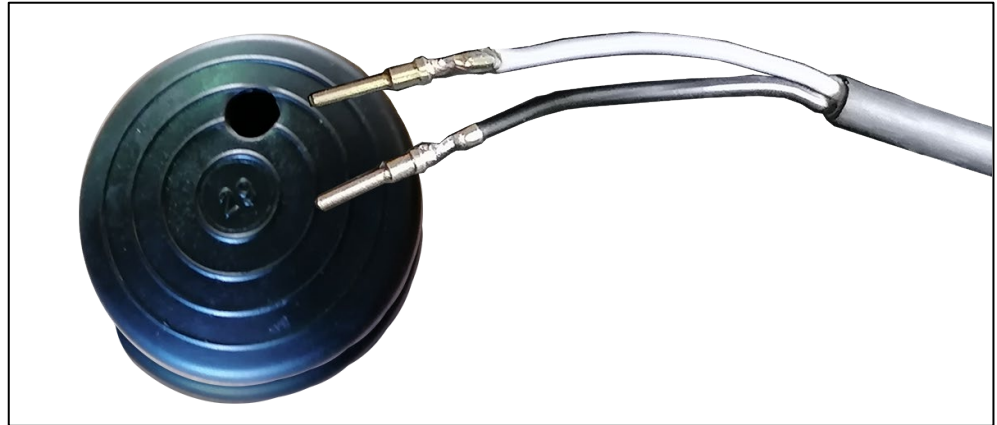

- ▶ Insert the cable with plug from the inside of the cab.
- ▶ Slide the corrugated tube on the cable.

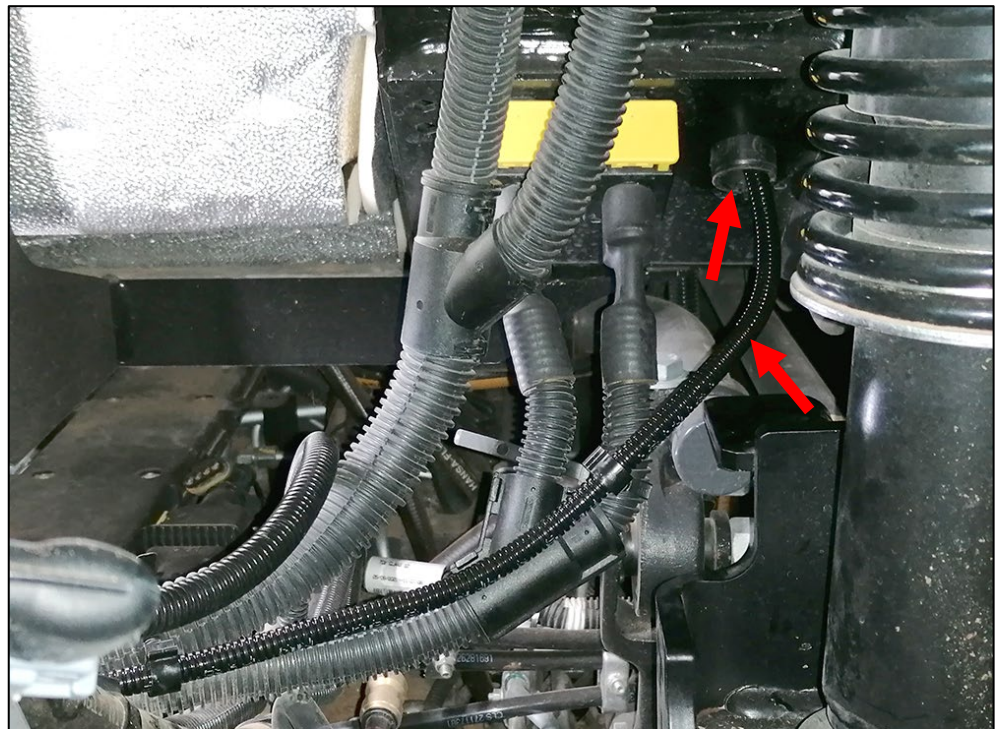

- ▶ Push the two jack contacts into the connector housing until they snap into place.
- ▶ Mount the wedge lock.



- ▶ Run the cable harness to the plug connection and plug it in.

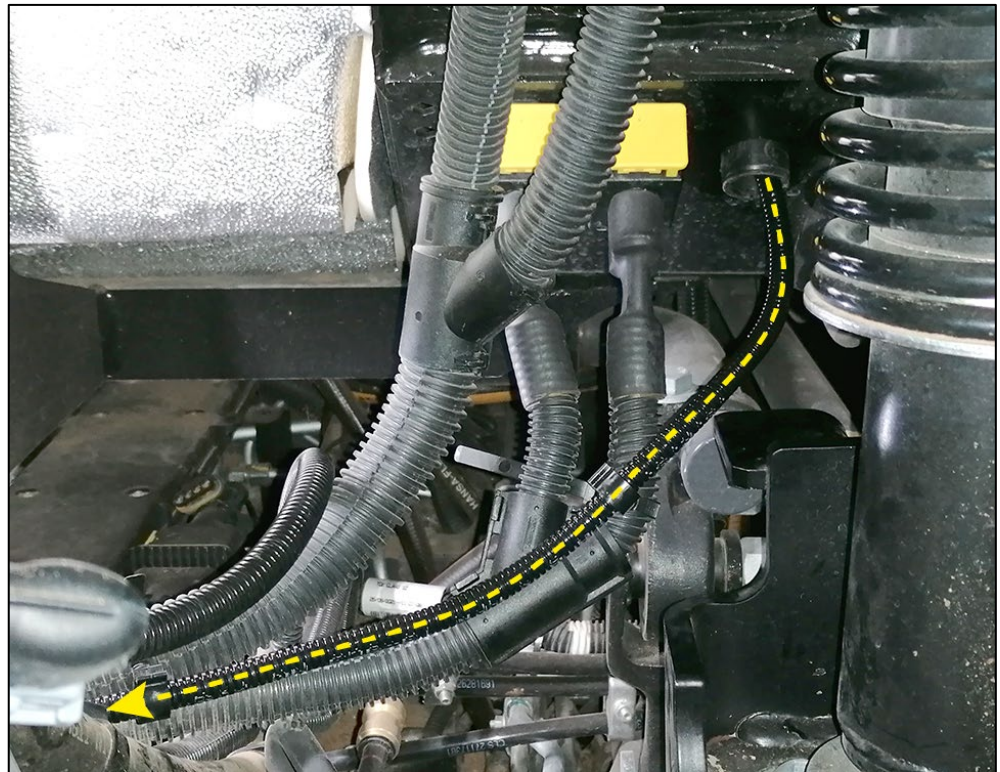

NOTE

Property damage due to contact of the corrugated tube with hot pipes!

- The minimum clearance of 10 mm (0.4") to other cables and tubes must be observed.
-
- ▶ Use the supplied rotatable corrugated tube holders to attach the corrugated tube to adjacent cables or tubes.

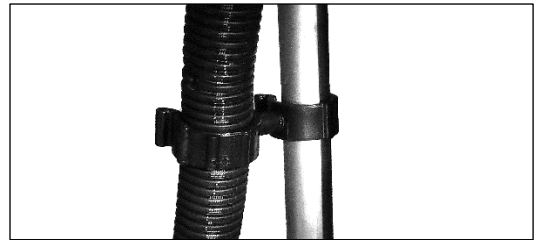
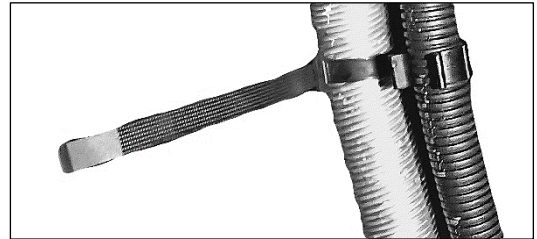

6.1.6 Connecting the Cleanfix® valve and switch to the vehicle's power supply

⚠ CAUTION!

Damage caused by lines or tubes that are too loose or are attached to moving parts!

During travel, the installed lines and tubes are subjected to vibrations. As a result, lines or nearby parts may be damaged due to friction.

- All lines and tubes must be securely fastened and must not make contact with moving parts.

- ▶ Unscrew the 3-pole outlet.



- ▶ Unplug the 3-pole outlet at the plug connection (green).
- ▶ Remove the 3-pole outlet.



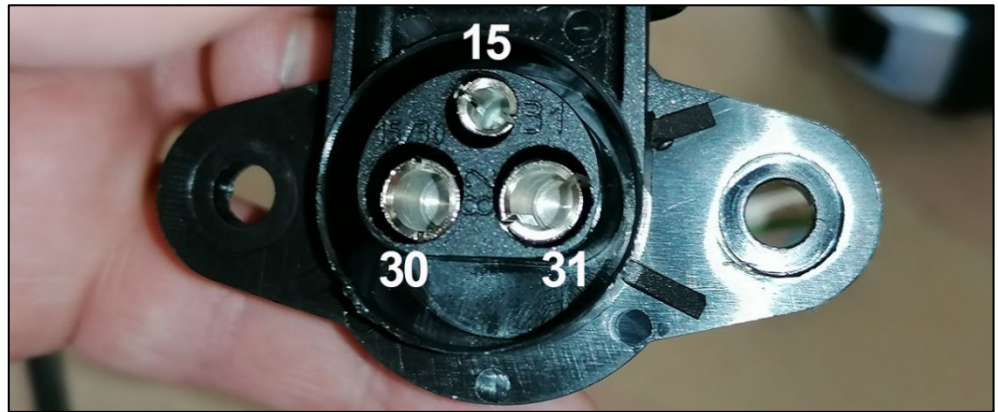

Terminal assignment of the 3-pole outlet

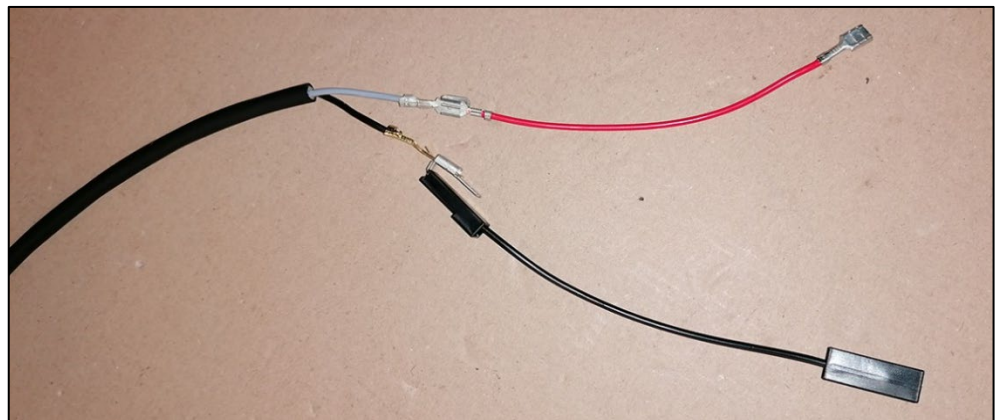

Cable harness extender for the 3-pole outlet

- ▶ Disconnect the cable (white/green with black shrink hose) at terminal 31.
- ▶ Disconnect the cable (gray) at terminal 15.

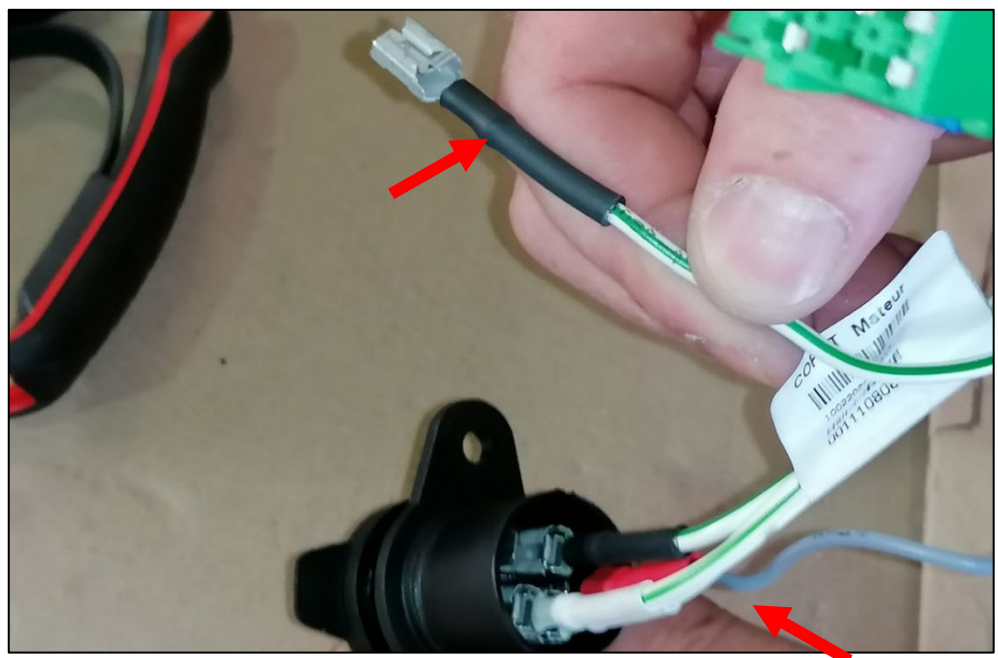

- ▶ Push each of the cables of the cable harness extender through a shrink hose.
- ▶ Plug the red cable into the 3-pole outlet at terminal 15.
- ▶ Plug the black cable into the 3-pole outlet at terminal 31.
- ▶ Guide the original white/green cable through the shrink hose of the black cable and plug it into the plug connection.
- ▶ Guide the original gray cable through the shrink hose of the red cable and plug it into the plug connection.
- ▶ Push both shrink hoses over the connections and shrink them with the hot-air gun.

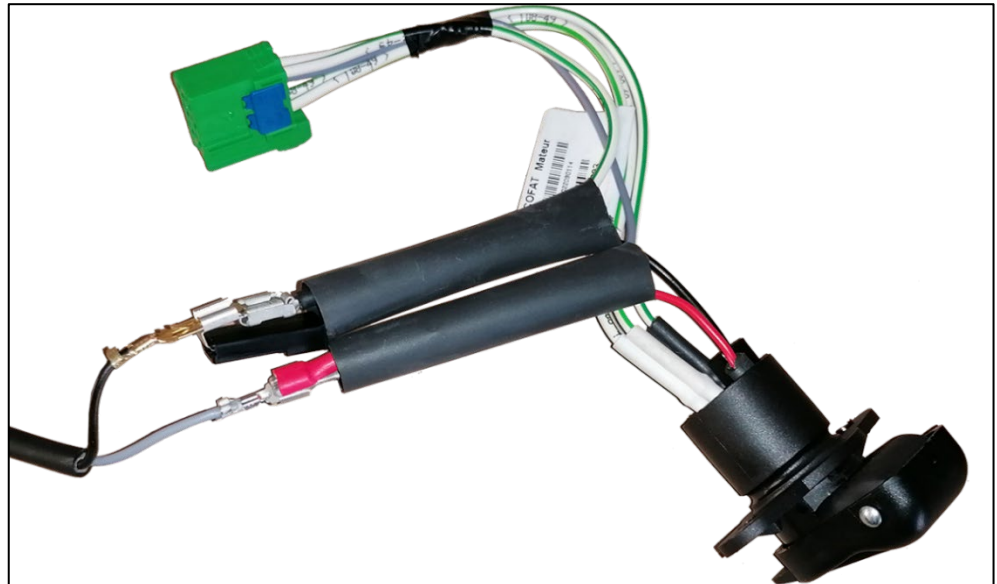

- ▶ Reinstall the 3-pole outlet in the side cover.
- ▶ Reinsert the plug connection (green) of the 3-pole outlet.
- ▶ Run the cable extender from the valve and the cable extender from the 3-pole outlet under the covers up toward the Cleanfix® push button installation location.

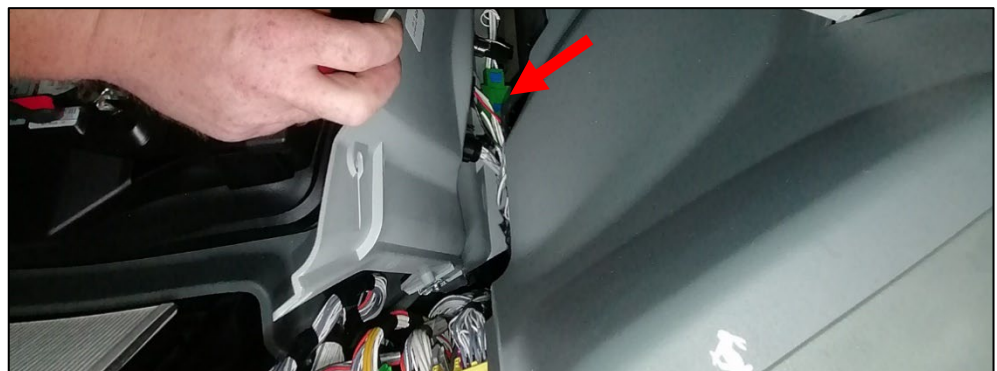

- ▶ Push both cable extenders through the mounting frame.
- ▶ Plug both gray cables into the Cleanfix® push button.
- ▶ Push a shrink hose over a black cable.
- ▶ Plug the two black cables together.
- ▶ Push a shrink hose over the plug connection and shrink it with the hot-air gun.



- ▶ Carry out a functional test (switch, valve).
- ▶ Mount the Cleanfix® push button in the mounting frame.



- ▶ Replace all covers and parts.



- ▶ Attach the "Cleanfix" label below the switch.



6.1.7 Mounting the Cleanfix speed sensor

Installation location: at the front right of the frame near the air filter

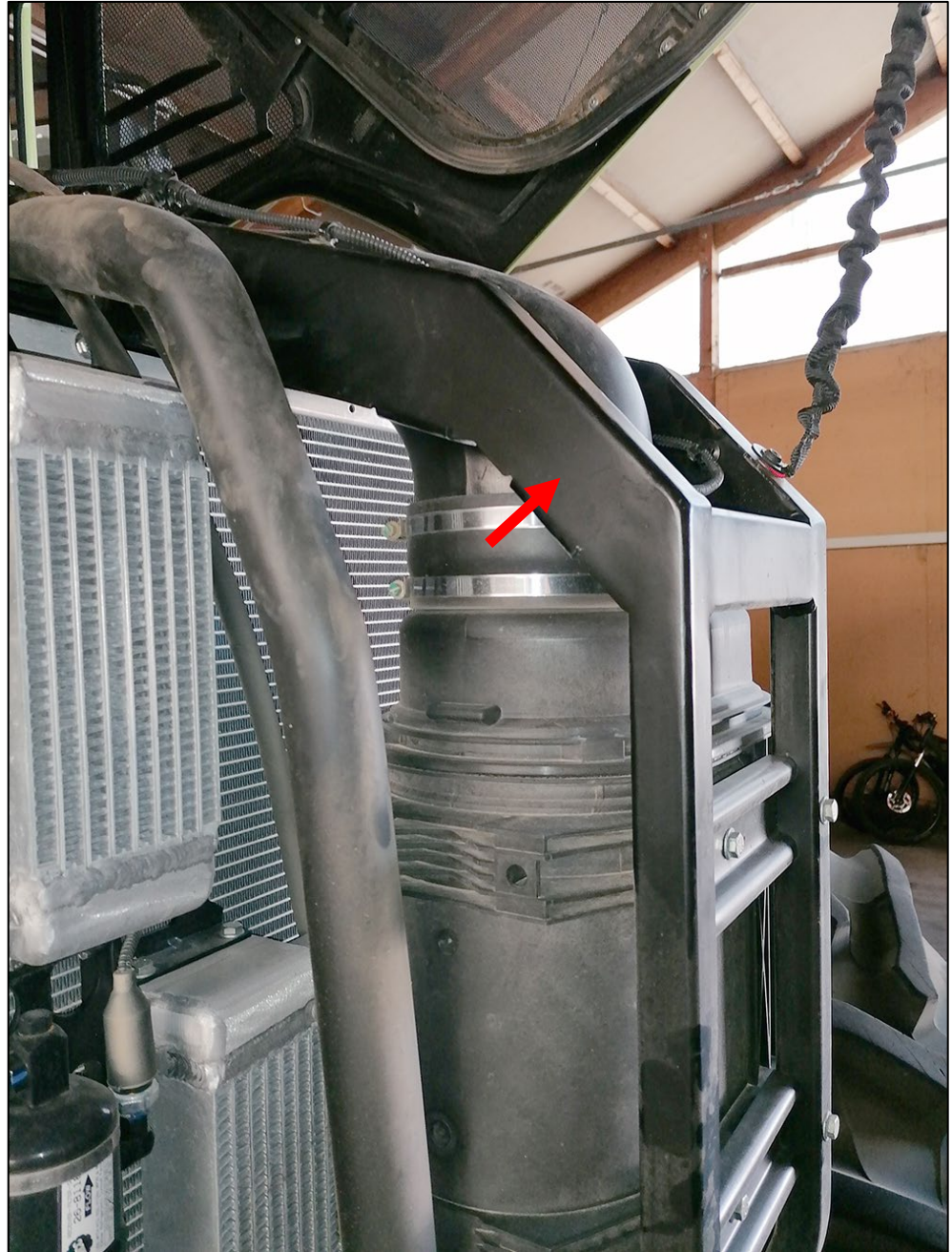

6.1.8 Preparing the frame

- ▶ Mark the position for drilling holes in the frame.
 - Measurement A (upper edge of frame) = 35 mm
 - Measurement B (hole spacing) = 65 mm
 - Measurement C (edge of the notch) = 10 mm

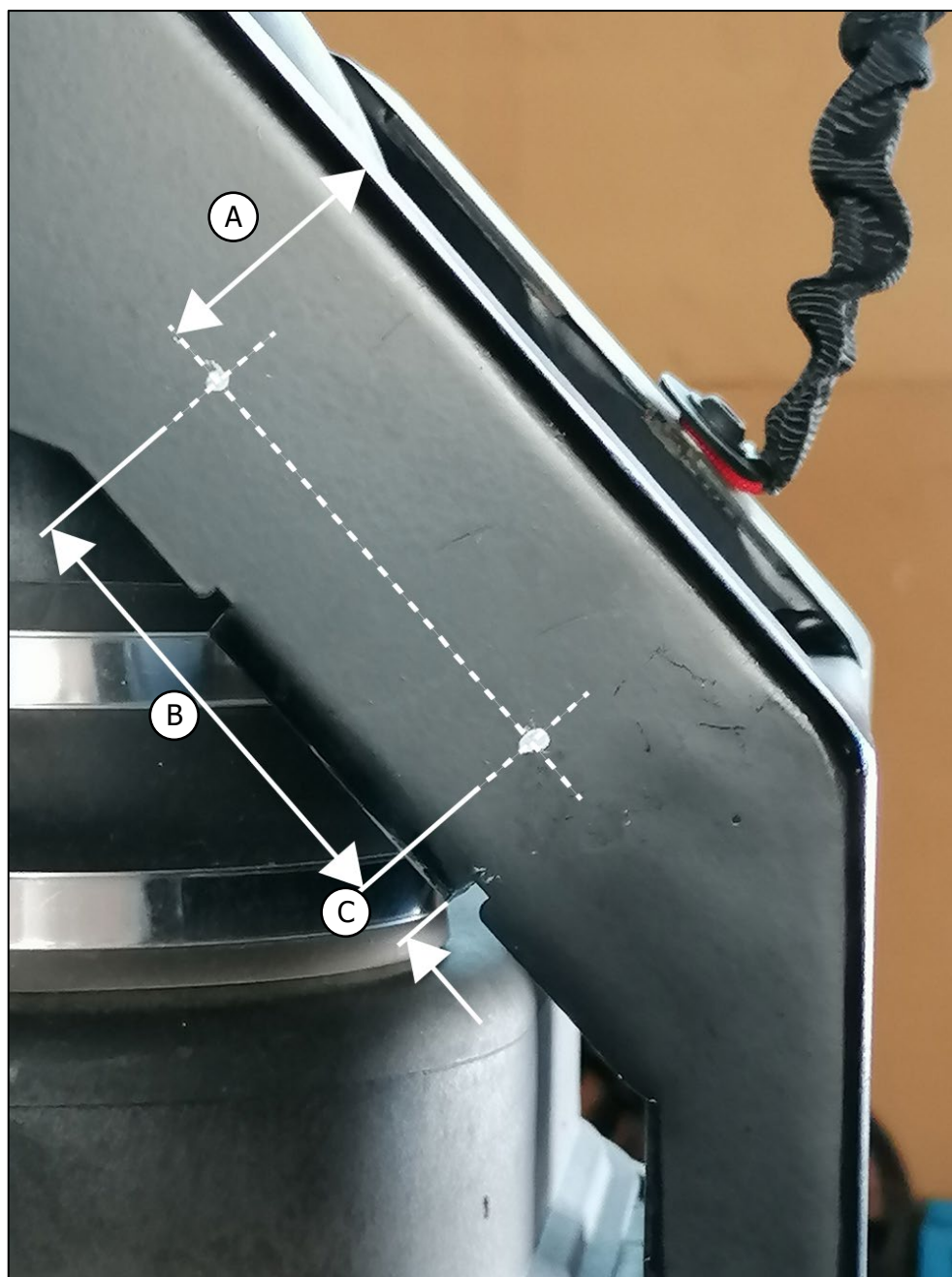

- ▶ Drill a 5 mm hole at both marks.
- ▶ Tap an M6 thread in both holes.
- ▶ Treat the threaded holes with an anti-corrosion coating.



6.1.9 Attaching the speed sensor

- ▶ Screw the speed sensor onto the frame using two M6 Allen screws and tighten it.



6.1.10 Adapting the cable/hose feedthrough

- ▶ Unscrew and remove the cover plate over the radiator.

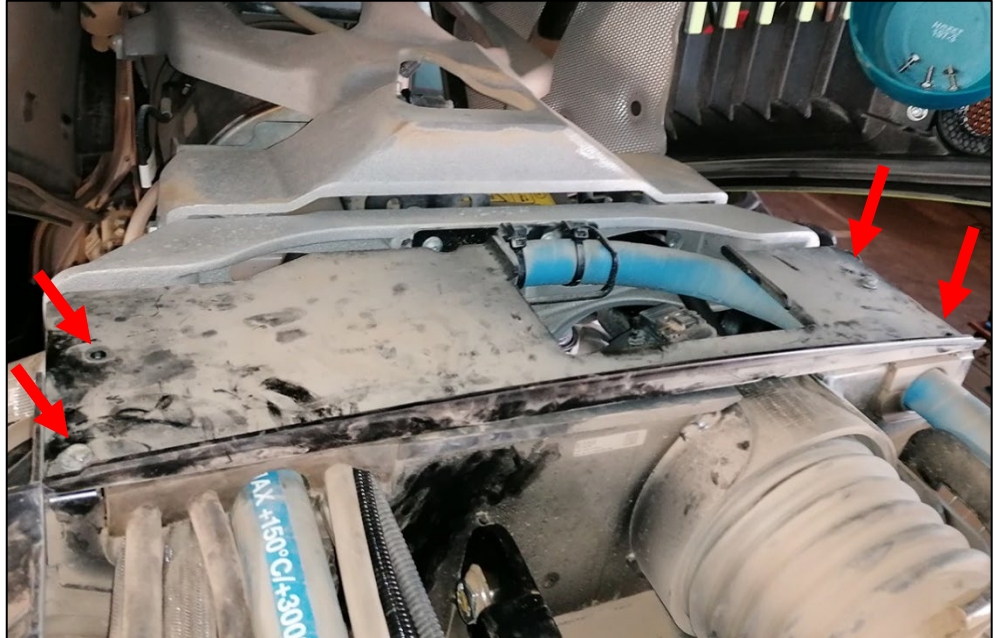

- ▶ Remove the molded foam of the cable/hose feedthrough.



- ▶ Cut off the spacer on the molded foam.



6.1.11 Running the speed sensor cables

- ▶ Run the speed sensor cables as pictured.



- ▶ Guide the speed sensor cabling through the molded foam where the spacer was cut off.
- ▶ Replace the adapted molded foam.
- ▶ Screw the cover plate back over the radiator.



- ▶ Run the cable with the corrugated tube to the viscous coupling interface.
- ▶ Run the cable with the crimped eyelet to the right side of the engine (generator).



- ▶ Insert the plugs into the original engine cable harness (viscous coupling interface).



- ▶ Run the cable with the crimped eyelet to the generator.

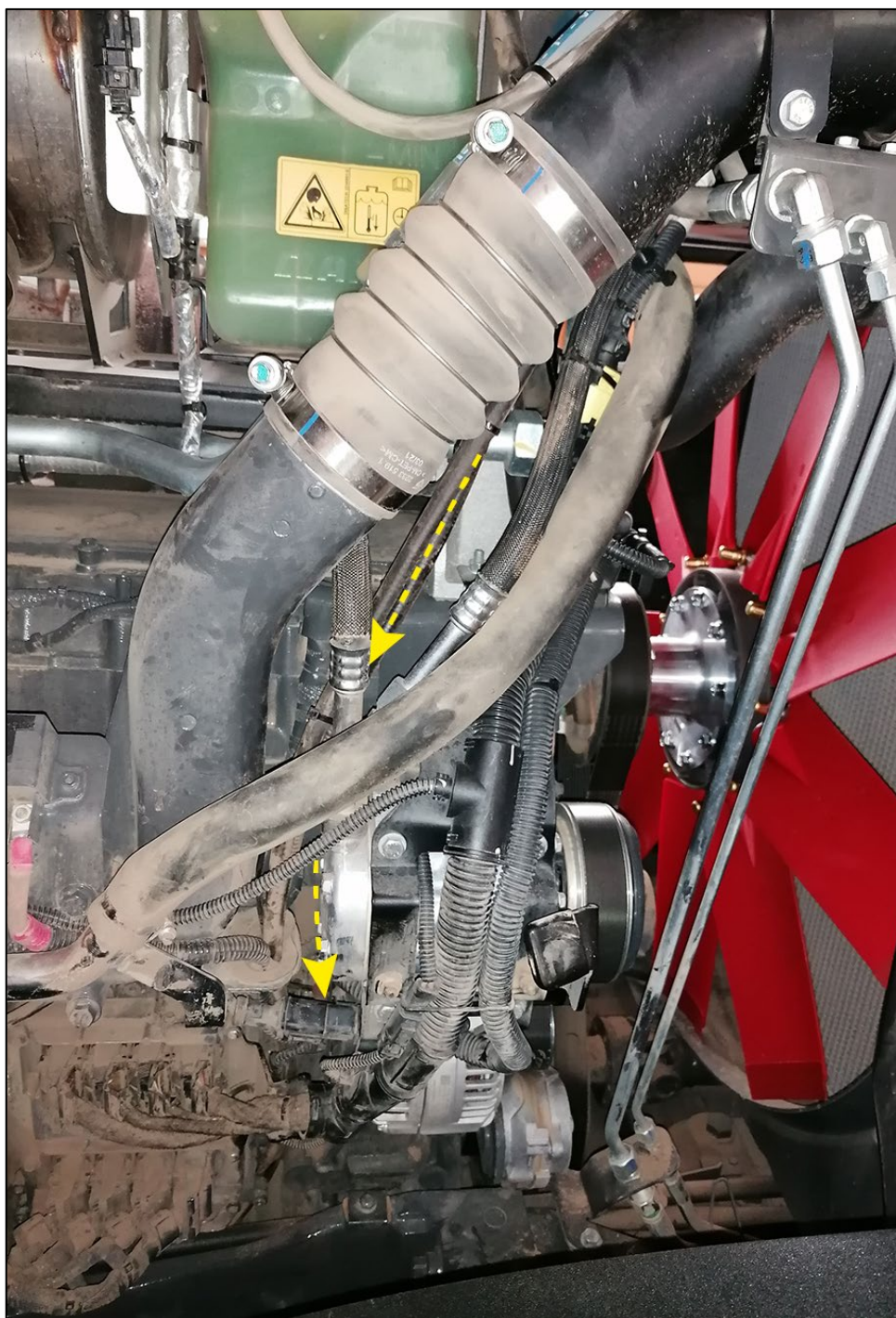

- ▶ Screw the cable to the generator (connection L) using a crimped eyelet.



NOTE

Property damage due to contact of the cable and the corrugated tube with hot pipes!

- The minimum clearance of 10 mm (0.4") to other cables and tubes must be observed.

- ▶ Use the supplied rotatable corrugated tube holders to attach the cable and corrugated tube to adjacent cables or tubes.

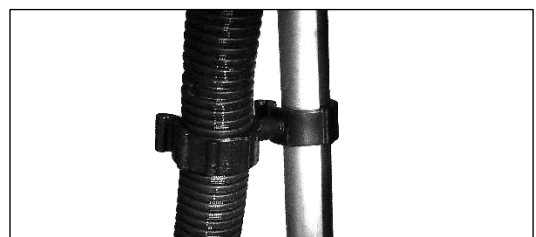
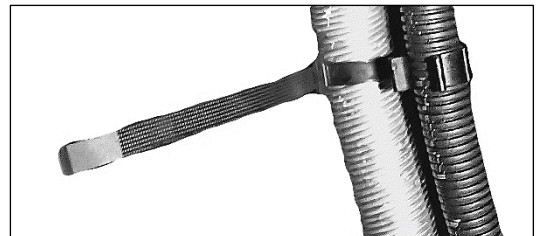

7 Operation

7.1 Initial start-up

WARNING!

Flying parts may result in serious injury or death!

Loose parts can be drawn in by the fan and may cause serious injury or death as well as machine damage.

- ▶ Remove tools and loose objects.
- ▶ Reliably secure components near the fan.

-
- ▶ Start the engine.
 - ▶ Reverse the fan three times in idle engine speed.



If Flex-Tips are used, slight abrasion of material will occur.

-
- ▶ Reverse the fan three times at approx. 1400 rpm.
 - ▶ Reverse the fan three times at approx. 1800 rpm.

7.2 Cleanfix® valve / for vehicles with a compressed air system

Press the push button to change from cooling to cleaning. The fan remains in cleaning mode for as long as the switch is pressed.



Cleaning mode

The cleaning power depends on the speed of the fan. The higher the motor speed, the stronger the cleaning power. The changeover can be performed at full speed.

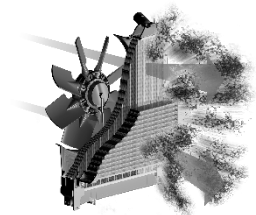

8 Maintenance

8.1 Servicing the Cleanfix[®] reversible fan

Cleanfix[®] reversible fans are maintenance-free.

8.2 Servicing the Cleanfix[®] electrical components

Cleanfix[®] valve units are maintenance-free.

9 Troubleshooting

9.1 Troubleshooting Cleanfix® reversible fans

Error	Cause of error	Troubleshooting
1 Blades do not rotate to the cleaning position	<p>→ 1.1 No or low compressed air supply</p> <p>(with a compressed air system)</p>	<p>→ 1.1.1 Check the compressed air supply at the solenoid valve.</p> <p>Compressed air supplied at the solenoid valve → see 1.1.2</p> <p>→ If no pressure is being applied to the solenoid valve, check the compressed air supply (min. 6.5 bar or 94 psi / max. 8 bar or 116 psi).</p> <hr/> <p>↳ 1.1.2 Check the functioning of the solenoid valve.</p> <p>If necessary, connect external power supply. (Please note: voltage 12 V or 24 V only)</p> <p>Solenoid valve switches (soft clicking) → see 1.1.3</p> <p>→ If the solenoid valve does not switch, replace the valve.</p> <hr/> <p>↳ 1.1.3 Check the pressure hose.</p> <p>If necessary, pull the pressure hose from the valve and connect it to the vehicle shop compressed air supply (max. 8 bar / 116 psi) to locate possible leaks faster.</p> <p>The pressure hose from the solenoid valve to fan has no kinks or leaks → see 1.1.4</p> <p>→ In the case of leaks in the hose, the hose needs to be replaced.</p> <p>→ When the air intake assembly on the fan is leaking, an appropriate seal kit must be ordered.</p>



1.1.4 Mechanical failure.

If all the above conditions are met and the blades do not rotate, then the trouble is a mechanical error. The fan must be sent to the manufacturer for testing.

2 Blades do not return from the cleaning position to the cooling mode

 **2.1** Fan speed is too high

 **2.1.1** Reduce the speed.

 **2.1.2** Install more springs if possible.

Additional springs increase the release force. The fan must be sent to the manufacturer.

 **2.2** Fan cannot vent anymore

 **2.2.1** Check the pressure hose.

The pressure hose from the solenoid valve to fan has no kinks or pinched positions
 → see 2.2.2

 **2.2.2** Check the functioning of the solenoid valve.

If necessary, connect external power supply. (Please note: voltage 12 V or 24 V only)

Solenoid valve switches (soft clicking)
 → see 2.2.3

 If the solenoid valve does not switch, replace the valve.

 **2.2.3** Mechanical failure

If the fan with hose disconnected does not turn back in the idle state, there is a mechanical failure. The fan must be sent to the manufacturer for testing.

